

## Wildlife Protection Products



© Jerry Liguori



# Wildlife Protection and Deterrent Hardware Solutions

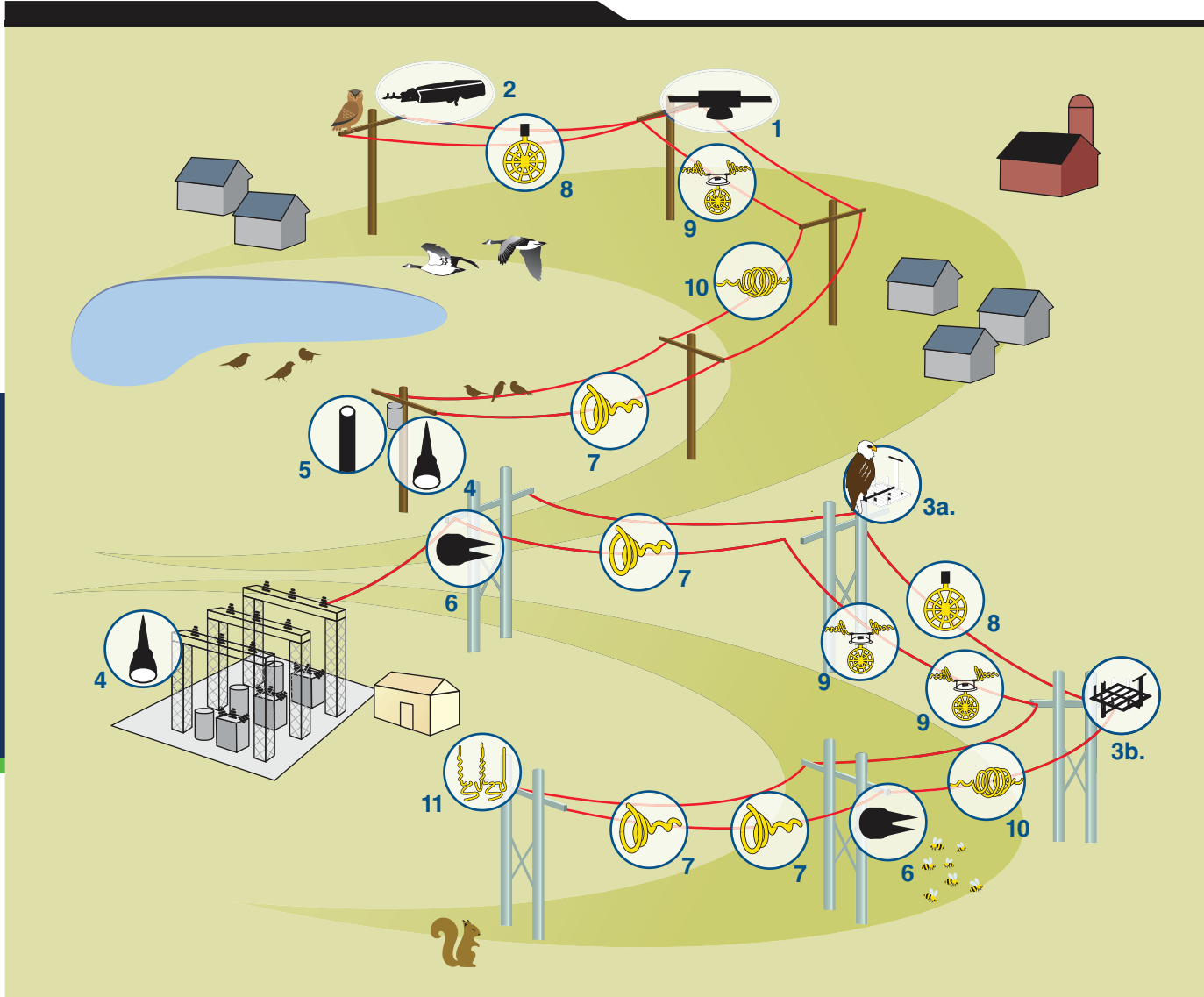

## Solutions Key

### Protect

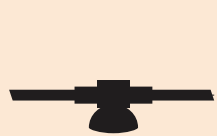

1. RAPTOR PROTECTOR™

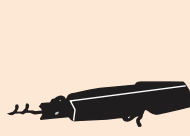

2. RAPTOR PROTECTOR™  
Dead-End Cover



3a. RAPTOR PROTECTOR™  
Platform Top-of-Pole



3b. RAPTOR PROTECTOR™  
Platform Side-of-Pole



4. Bushing  
Covers

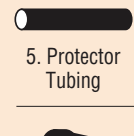

5. Protector  
Tubing



6. POLE PLUG

### Divert



7. BIRD-FLIGHT™  
Diverters



8. RAPTOR CLAMP™  
Diverters



9. OWL Diverters



10. SWAN-FLIGHT™ Diverters



11. BIRD PERCH DETERRENT



# **PREFORMED** LINE PRODUCTS

## **Wildlife Protection Products**

### **Table of Contents**

#### **RELOCATE**

RAPTOR PROTECTOR™ Platform .....	4
----------------------------------	---

#### **PROTECT**

RAPTOR PROTECTOR™ .....	6
-------------------------	---

Bushing Covers .....	11
----------------------	----

Protector Tubing .....	13
------------------------	----

Pole Plugs.....	14
-----------------	----

#### **DIVERT**

BIRD-FLIGHT™ Diverters.....	16
-----------------------------	----

SWAN-FLIGHT™ Diverters.....	18
-----------------------------	----

RAPTOR CLAMP™ Diverters .....	20
-------------------------------	----

RAPTOR CLAMP™ LED Diverters.....	20
----------------------------------	----

Overhead Warning Light (OWL) Diverters.....	20
---	----

#### **PREVENT**

BIRD PERCH DETERRENT™ .....	22
-----------------------------	----



## Wildlife Protection

With the power grid expansion across the globe, the impact on wildlife populations became evident. As migratory bird collisions with power lines and other wildlife interactions with power equipment increased, Preformed Line Products worked with electric power utilities to develop product solutions that mitigate wildlife interactions.

**Preformed Line Products (PLP)** is committed to protecting wildlife by working with utility companies to design and manufacture wildlife protection products that aid in reducing wildlife mortalities from interaction with power lines, structures, and equipment.

## Power Reliability

Wildlife-related outages impact power reliability, a key metric in the industry. Wildlife interactions is one of the top causes of power loss, behind Mother Nature and equipment failures. Loss of power by wildlife is estimated to cost utility companies millions in revenue due to cost of repair, customer outages, and regulatory fines.

**Preformed Line Products** is committed to improving power reliability by working with utility companies to develop and deliver wildlife protection products that aid in reducing outages caused by wildlife.





# RELOCATE

**RELOCATE** away from energized equipment.

The osprey is one of the most widespread birds of prey and can be found on every continent except Antarctica.



Electrocutions kill tens of thousands of birds per year mainly when large birds, such as raptors, make contact between a live electrical conductor and a ground.



# RAPTOR PROTECTOR™ Platform



© Jerry Liguori

The **RAPTOR PROTECTOR Platform** is designed to provide the raptor an alternative to nesting on utility structures, where they are in danger of electrocution. The RAPTOR PROTECTOR Platform also eliminates many outages caused by the raptors and their young due to electrical short circuits and the fowling of insulators.

The platform can be easily installed in a pole-top or side of pole application. The preassembled and lightweight platform can aide the utility in wildlife management and protection for years without maintenance.

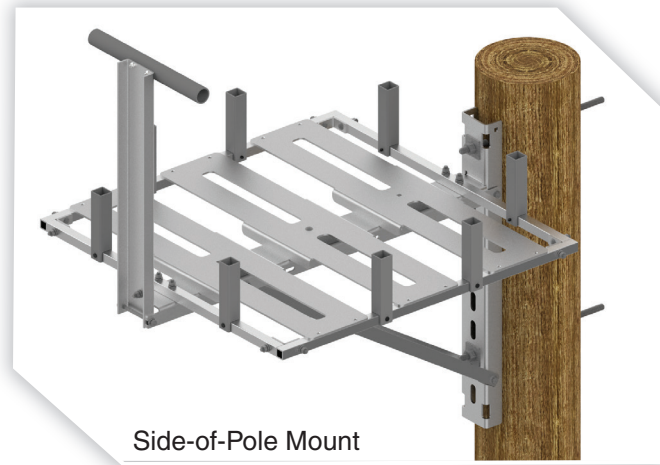

Side-of-Pole Mount

## Features

- Lightweight
- Easily installed
- No maintenance
- Installs on wood, steel or composite poles quickly
- Recyclable and reusable

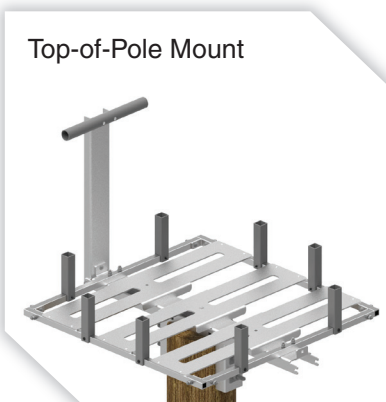

Top-of-Pole Mount

RAPTOR PROTECTOR PLATFORM		
PLP Catalog Number	Description	Dimensions
NEST33-T	Top-of-Pole Mount	3' x 3'
NEST33-ET	Extended Pole Top	3' x 3'
NEST33-S	Side of Pole Mount	3' x 3'
For nest retention posts, add suffix NR (Example: NEST33-SNR) For perch, add suffix 24, (24") (Example: NEST33-SNR24)		
<b>For larger platforms, please contact PLP.</b>		

# PROTECT

**PROTECT** from incidental contact with energized lines.

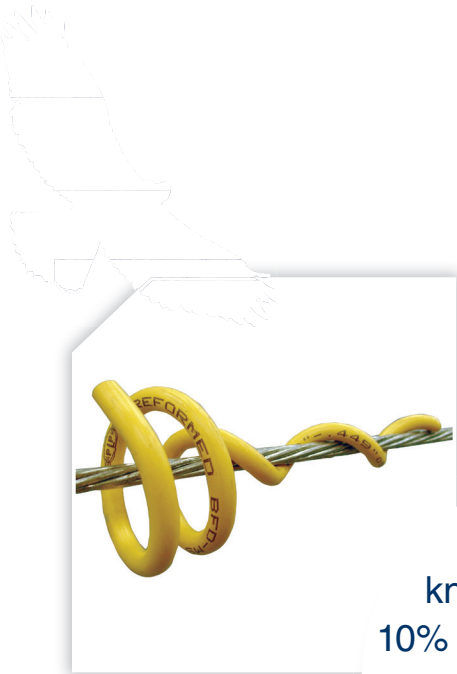

Did you know that nearly 10% of power outages are caused by wildlife interactions with power lines or equipment?

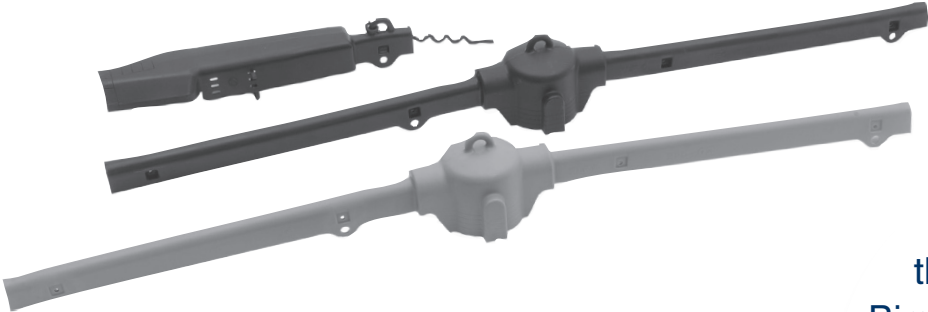

Did you know that the Migratory Bird Treaty Act requires utilities to protect against injuring or killing endangered species like the Bald Eagle?





# RAPTOR PROTECTOR™



© Jerry Liguori

The Patented **RAPTOR PROTECTOR COVER (RPC)** is designed to provide protection from incidental avian contact with overhead distribution lines. It provides an economical means of reducing bird fatalities and line outages. It is easily installed over single or double pin/post tie top C, F, J and K Neck insulators and on conductors up to 1.10". For double pin insulators, the RPC can accommodate 6.5" – 22" center to center distances. The heavy angle RPC can be used on angles up to 30°. The horizontal trunnion and vertical trunnion are available for vise top and trunnion style insulators.

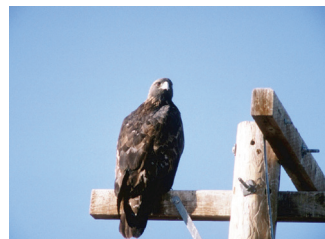



# RAPTOR PROTECTOR™

Patented

## 4 Styles



## Features

- Lightweight
- Fully UV Stabilized
- Long service life without deterioration of material
- 35 kV dielectric strength
- Low profile
- Unobtrusive appearance
- Minimized wind loading

## Application

- Installs on single insulator in seconds
- Easily installed by hand or hot stick
- Designed to ensure a positive lock on conductor
- Modifiable for use on double crossarm construction
- Covers available for C, F, J and K-Neck, Vise Top and Trunnion style insulators

RAPTOR PROTECTOR					
PLP Catalog Number	Description	Diameter Range (in) Max.	Overall Length (in)	Max. Line Angle	Color
Tangent Cover					
RPC-0800-S	Tangent Cover	1.10	42"	10°	Black
RPC-0800			80"		Black
RPC-0801-S			42"		Gray
RPC-0801			80"		Gray
Heavy Angle					
RPC-0810-S	Heavy Angle	1.10	42"	30°	Black
RPC-0810			80"		Black
RPC-0811-S			42"		Gray
RPC-0811			80"		Gray
Horizontal Trunnion					
RPC-0820-S	Horizontal Trunnion	1.25	42"	10°	Black
RPC-0820			80"		Black
RPC-0821-S			42"		Gray
RPC-0821			80"		Gray
Vertical Trunnion					
RPC-0830-S	Vertical Trunnion	1.25	42"	10°	Black
RPC-0830			80"		Black
RPC-0831-S			42"		Gray
RPC-0831			80"		Gray

Four pins (RPP-0840) included with each kit. Contact PLP for other available options.

**NOTE: The RAPTOR PROTECTOR is not a completely insulating covering and should not be used to protect humans from electrical shock. Will fit on K-Neck insulators.**



## RAPTOR PROTECTOR™ Dead-End Cover



The Patented **RAPTOR PROTECTOR Dead-End Cover** is designed to provide protection from incidental avian contact with overhead distribution lines. It provides an economical means of reducing bird fatalities and line outages while being easily installed over dead-end terminations.

The RAPTOR PROTECTOR Dead-End Cover is lightweight, offers little wind resistance and is easily and quickly installed by hand or by hot stick. It is designed to remain in its applied location and will not move along the conductor under Aeolian vibration or other motion. This product comes with a pigtail attachment to hold the cover in place over the termination and an anti-lift block to keep the RAPTOR PROTECTOR Dead-End Cover on the termination.



The RAPTOR PROTECTOR is manufactured from low density polyethylene (LLDPE) possessing excellent environmental stress crack resistance and is fully UV stabilized.

# RAPTOR PROTECTOR™ Dead-End Cover



## Features

- Lightweight
- Low profile
- Unobtrusive appearance
- Covers a wide range of conductors and dead-end hardware
- Long service life without deterioration of material
- 35 kV dielectric strength
- Easily installed by hand or hot stick
- Includes pigtail and lift prevention block
- Fully UV stabilized
- Exceptional low temperature impact resistant
- Installs on conductor and over dead-end configuration in seconds
- Quick modification for a custom fit
- Two cover sizes accommodate large and small configurations of bulky dead-end hardware
- Lift prevention block keeps the cover shell from lifting off the conductor and hardware
- Patented

RAPTOR PROTECTOR Dead-end SMALL			
PLP Catalog Number	Overall Length (in)	Range (in)	Color
RPC-0850B-0295	30"	.175 - .295"	Black
RPC-0850G-0295			Gray
RPC-0850B-0400	30"	.296 - .400"	Black
RPC-0850G-0400			Gray
RPC-0850B-0540	30"	.401 - .540"	Black
RPC-0850G-0540			Gray
RPC-0850B-0730	30"	.541 - .730"	Black
RPC-0850G-0730			Gray

RAPTOR PROTECTOR Dead-end LARGE			
PLP Catalog Number	Overall Length (in)	Range (in)	Color
RPC-0860B-0730	30"	.541 - .730"	Black
RPC-0860G-0730			Gray
RPC-0860B-0920	30"	.731 - .920"	Black
RPC-0860G-0920			Gray
RPC-0860B-1100	30"	.921 - 1.100"	Black
RPC-0860G-1100			Gray
RPC-0860B-1300	30"	1.101 - 1.300"	Black
RPC-0860G-1300			Gray

Contact PLP for other available options.

**NOTE: The RAPTOR PROTECTOR is not a completely insulating covering and should not be used to protect humans from electrical shock.**





# RAPTOR PROTECTOR™

Patented



## Accessories for Applications

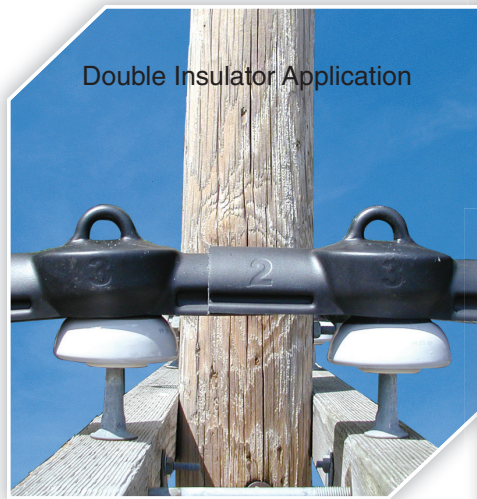

Double Insulator Application

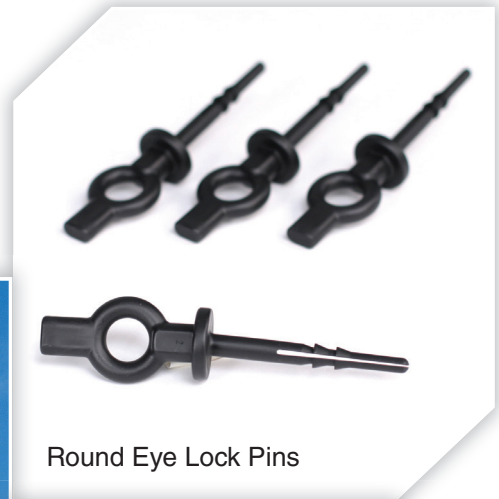

Round Eye Lock Pins

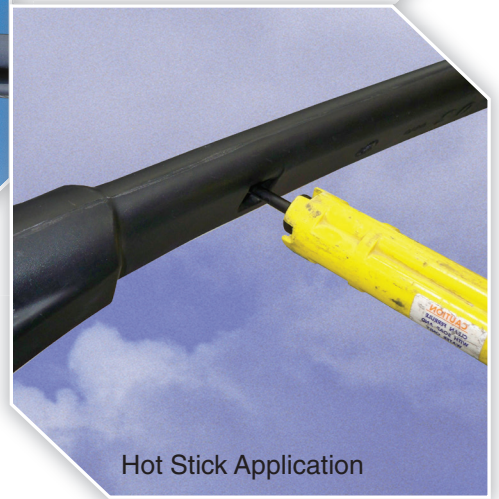

Hot Stick Application

# Bushing Covers



Prevent outages and protect wildlife with PLP's **Bushing Covers**. The Bushing Covers are designed to reduce the number of outages experienced on the utility's distribution system by covering the connectors on transformer bushings, lighting arrestors, capacitors and switching equipment from incidental contact by various animals.

PLP Bushing Covers are made from a light gray, high dielectric, plastisol compound that is a minimum of 100 mils thick. This material contains ultraviolet stabilizers and fungicides and has a dielectric strength of 240 V/mil. Plastisol guards are secured to the bushings of transformers or similar equipment so that the energized components are covered



for a reasonable distance or the insulating medium separates energized components from grounded components in areas open to animal contact.



# Bushing Covers

## Features

- Lightweight
- One-piece design
- Installed in seconds by hand
- Variety of shapes for various transformer configurations
- Modifiable for larger/smaller stinger wires
- UL94 fire rating of V-0



WILDLIFE PROTECTORS						
PLP Catalog Number	Description	Carton Quantity	Height (in)	Width (in)	Length (in)	Tap Wire Opening (in)
WP-CLF15 <sup>1</sup>	Recloser current limiting fuse protection	30	21.50	3.75	3.75	cut as needed
WP-10T	Single bushing transformer and capacitor. Covers a maximum of 7.5" of tap wire. Locating tabs hold the guard on the first skirt of the insulator.	25	11.75	3.75	3.75	up to 0.75
WP-17T	Single bushing transformer and capacitor. Covers a maximum of 12.5" of tap wire. Locking tabs hold the guard on the first skirt of the insulator.	20	17.00	3.75	3.75	up to 0.75
WP-11S	Existing tap retrofit. Apply through slit edge and hold guard in place with the fasteners provided.	25	11.00	3.50	3.50	0.40
WP-CSP	Completely Self-Protected (CSP) transformers. Designed as retrofit. Designed to protect both primary bushing and lighting arrestor.	20	8.75	3.50	12.25	0.40
WP-2.25F <sup>1</sup>	Single bushing transformer. Covers 2.25" OD current limiting fuse bolted to bushing. Bottom of the double dipped tip indicates point of install for fuse. Locking tabs hold guard on first skirt of the insulator.	20	12.75	3.75	3.75	cut as needed

<sup>1</sup>Designed for use with current limiting fuse.

# Protector Tubing

**Protector Tubing** protects energized lines from faults due to incidental contact caused by various species of wildlife. The overlapping design provides 360° coverage of the conductor even in jumper applications. With the overlapping design, it ensures no conductor exposure. The durable EPDM tubing is a minimum of 125 mils thick with a dielectric strength of 500 V/mil and has excellent resistance to ozone and petroleum-based solvents.

- Tubing slit configuration permits easy installation on existing conductor
- Overlapping profile follows bends and turns in the conductor without risk of splitting open exposing energized wire
- New profile provides for a wider ranging of conductor applications
- Ideal for transformer stinger wires and arrestor connections to prevent the electrocution of birds of prey
- Available in continuous rolls. Contact PLP with your requirements.
- Not for the protection of human contact

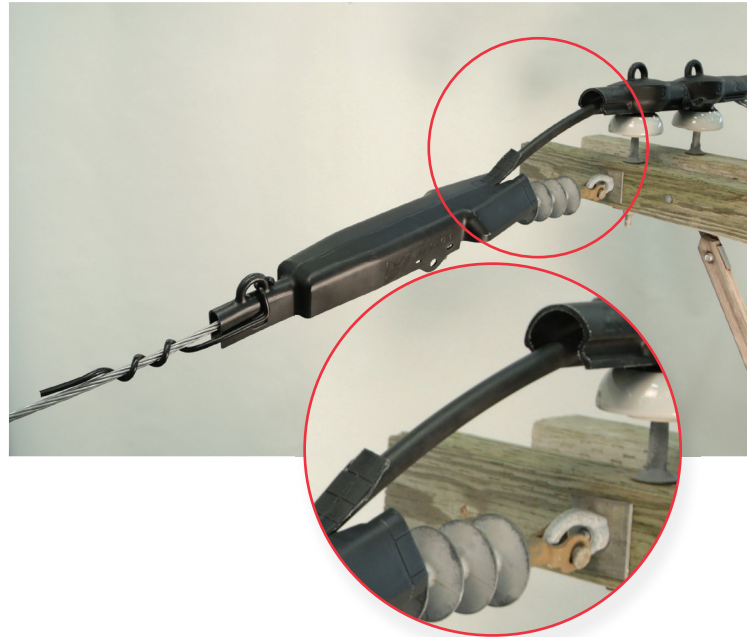

PROTECTOR TUBING			
PLP Catalog Number	Conductor Range		Length (ft)
	Min (in)	Max (in)	L
PT-0375	0.162	0.375	8
PT-0375-50			50
PT-0625	0.376	0.625	8
PT-0625-50			50
PT-0938	0.626	0.938	8
PT-0938-50			50
PT-1300	0.939	1.30	8
PT-1300-50			50
PT-1750	1.31	1.75	8
PT-1750-50			50





# Pole Plug

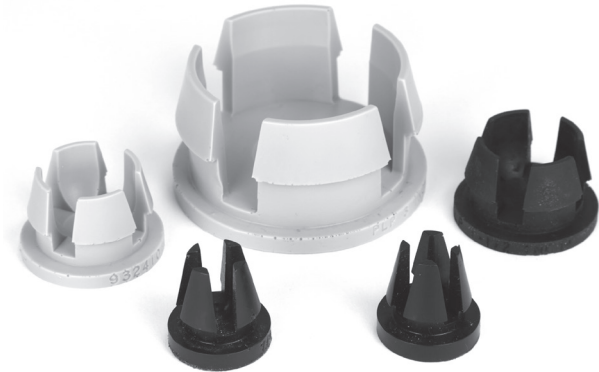

The **Pole Plug** is designed to close

existing holes in steel and composite utility poles or other equipment.

Closing unused holes reduces or eliminates whistling due to the wind.

The plug also provides an economical means of reducing the incidents of insect infestations. This can drastically reduce injury to linemen and loss of productivity.

## Features

- Fully UV stabilized
- Resistant to environmental stress cracking
- Installs in seconds
- Can be installed with standard hot stick tools if required
- Positive snap in lock
- One piece design
- Lightweight
- Eliminate/reduce pole whistling
- Eliminate/reduce insect or wildlife infestation
- Covers a wide range of hole diameters
- Long service life without material deterioration
- Compatible with steel or composite poles with wall thickness of 1/4" (9/16" to 1-1/8" diameter), 3/8" or less (1/2" diameter), or 1/2" or less (3" diameter)

POLE PLUG		
PLP Catalog Number	Hole Size (in)	Color
PP-0625B	9/16" and 5/8"	Black
PP-0625G		Gray
PP-0750B	11/16" and 3/4"	Black
PP-0750G		Gray
PP-0813B	13/16"	Black
PP-0813G		Gray
PP-0875B	7/8" and 15/16"	Black
PP-0875G		Gray
PP-1000B	1"	Black
PP-1000G		Gray

POLE PLUG		
PLP Catalog Number	Hole Size (in)	Color
PP-1125B	1-1/8"	Black
PP-1125G		Gray
PP-1250B	1-1/4"	Black
PP-1250G		Gray
PP-1375B	1-3/8"	Black
PP-1375G		Gray
PP-1500B	1-1/2"	Black
PP-1500G		Gray
PP-3000B	3"	Black
PP-3000G		Gray



# DIVERT



**DIVERT by making overhead lines more visible.**

Divert avian flight patterns over distribution and transmission lines by making the lines more visible.

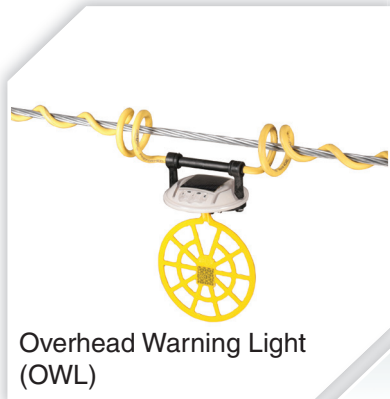

Overhead Warning Light (OWL)



BIRD-FLIGHT™ Diverter

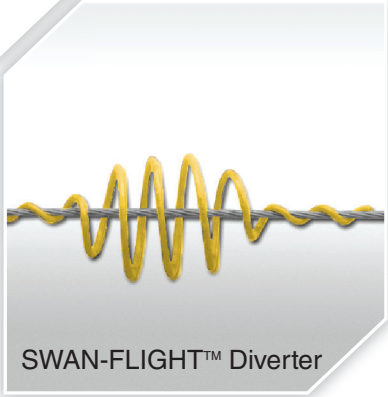

SWAN-FLIGHT™ Diverter

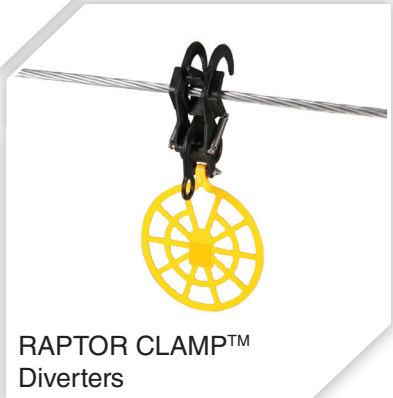

RAPTOR CLAMP™ Diverter



## BIRD-FLIGHT™ Diverter

The **BIRD-FLIGHT Diverter (BFD)** is designed to make overhead lines and guyed structures visible to birds and provides an economical means of reducing the hazard to both lines and birds. For low and medium voltage construction, the BFD is applied to the phase conductors (bare or jacketed). For high voltages, it is typically used on the shield wire.

The BIRD-FLIGHT Diverter is lightweight, offers little wind resistance and is easily and quickly applied by hand or by hot stick. The positive grip on the conductor is designed to ensure that the BFD remains in the applied position and cannot move along the span under aeolian vibration or other motion. The diverter section increases the visible profile of the cable or conductor to a degree necessary to alert wildlife, but avoids an undesirably bulky outline and increased loading on the line.

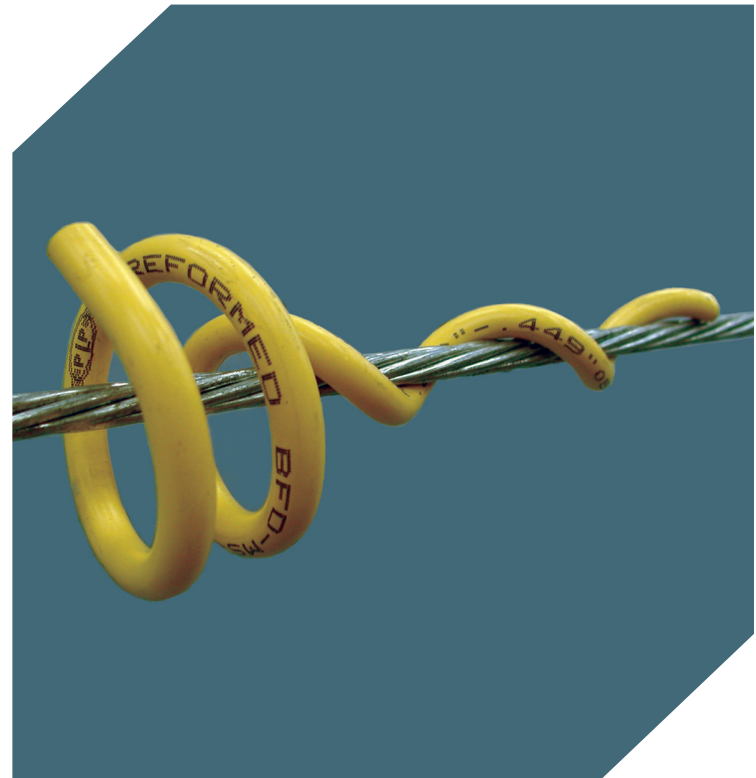

The plastic BFD is manufactured from rigid high impact polyvinyl chloride (PVC) possessing excellent chemical resistance and tensile strength properties. The BFD will retain good physical characteristics over a range of extreme temperatures. Aging tests confirm that the material does not deteriorate in function or appearance from the effects of severe weather conditions. Industrial fumes

and salt water can not seriously degrade the properties of rigid PVC.

The aluminum BFD is manufactured from a high strength, corrosive resistant aluminum alloy material. It is designed for use on conductors operated at elevated temperatures (up to 250°C).



# BIRD-FLIGHT™ Diverter

**BIRD-FLIGHT Diverters are designed to offer the following advantages:**

- Increased conductor/strand profile to enhance visibility where bird flight paths are present
- Economical and easily applied
- Lightweight
- No moving parts to wear out
- Long service life without deterioration of material properties
- Minimal wind resistance
- Manufactured from gray or yellow high impact PVC with UV protection (Contact PLP for other color/voltage options).

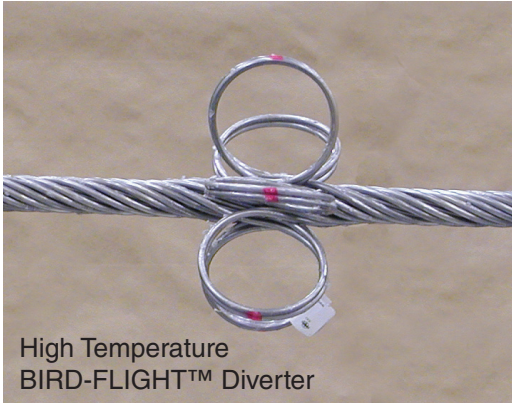

**For use on: Bare and Jacketed Conductors and Strand**

Catalog Number (YELLOW)	Catalog Number (GRAY)	Conductor Range inches (mm)		Overall Length inches (mm)	Outer Diameter of Diverter Coil inches (mm)	Color Code
		Min	Max			
BFD-MS-3331	BFD-MS-3346	.175 (4.4)	.249 (6.3)	8.00 (203)	2.25 (57)	Black
BFD-MS-3155	BFD-MS-2921	.250 (6.4)	.349 (8.9)	8.50 (216)	2.50 (64)	Blue
BFD-MS-3164	BFD-MS-3355	.350 (8.9)	.449 (11.4)	9.50 (241)	<b>2.75 (70)</b>	<b>Brown</b>
BFD-MS-11135	BFD-MS-11060			12.37 (314)	<b>4.25 (108)</b>	<b>Brown</b>
BFD-MS-3341	BFD-MS-3366	.450 (11.4)	.599 (15.2)	14.50 (368)	4.25 (108)	Green
BFD-MS-3344	BFD-MS-3371	.600 (15.2)	.770 (19.6)	17.00 (432)	4.25 (108)	Purple
BFD-MS-3345	BFD-MS-3376	.771 (19.6)	.858 (21.8)	15.00 (381)	4.25 (108)	Red
BFD-MS-3405	BFD-MS-11699	.859 (21.8)	.970 (24.6)	16.50 (419)	4.50 (114)	Orange
BFD-MS-11111	BFD-MS-12290	.971 (24.7)	1.121 (28.5)	15.50 (394)	5.13 (130)	Pink
High Temperature BIRD-FLIGHT™ Diverter						
BFD-MS-11543	Aluminum	0.800	0.850	26.00	4.00	Pink
BFD-MS-12679		1.100	1.150	37.00	4.00	Purple
BFD-MS-12645		1.300	1.350	43.00	4.00	Red
BFD-MS-12687		1.565	1.635	54.00	4.00	Black



## SWAN-FLIGHT™ Diverter



The **SWAN-FLIGHT Diverter (SFD)** is designed for use on conductor/strand to create greater visibility for avian flight paths on overhead lines and tower down guys. Offering little wind resistance, the SFD reduces hazards to both lines and birds. For construction up to 230kV, the SFD can be applied to phase conductors (bare or jacketed). For EHV voltages, it is typically installed on the shield wire.

The SWAN-FLIGHT Diverter is lightweight, offers little wind resistance and is easily and quickly applied. The positive grip on the conductor ensures that the SFD remains in the applied location and cannot move along the span under Aeolian vibration or other motion. The diverter section increases the visible profile of the cable to a degree necessary to alert wildlife, but avoids an undesirably bulky outline and increased loading on the line.

The SWAN-FLIGHT Diverter (SFD) is manufactured from rigid high impact



polyvinyl chloride (PVC) possessing excellent chemical resistance and tensile strength properties. The SFD will retain good physical characteristics over a range of extreme temperatures.

Aging tests confirm the material does not deteriorate in function or appearance from the effects of severe weather conditions.

Industrial fumes and

salt water cannot seriously degrade the properties of rigid PVC. For application on phase conductors above 345kV, contact PLP for recommendations.

# SWAN-FLIGHT™ Diverter



## Features:

- Increased conductor profile to provide increased visibility where large, slow moving bird flight paths are present
- Economical and easily applied
- Lightweight
- Long service life without deterioration of material properties
- Minimal wind resistance
- Manufactured from gray or yellow high impact PVC with UV protection



## Spacing:

For optimal results, spacing distances are generally recommended at 15' intervals, depending upon local conditions. Since wind resistance is very limited, sufficient SWAN-FLIGHT Diverters can be used to ensure adequate visibility without creating stresses on the line. When marking adjacent spans, overall visibility is improved by staggering the placement between the spans.

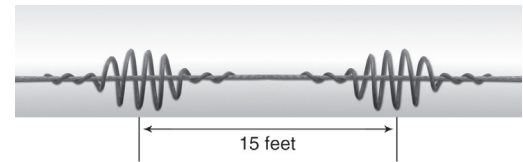

SWAN-FLIGHT Diverter - Product Data							
PLP Catalog Number	Conductor Range (Inches)		Overall Length (Inches)	Diameter of Diverter Coil (Inches)	Diameter of PVC Rod (Inches)	Approx. Weight (lbs)	Color Code
	Min	Max					
SFD-0445	0.175	0.249	20	7.0	0.375	0.40	Black
SFD-0635	0.250	0.349	23	7.0	0.375	0.46	Blue
SFD-0890	0.350	0.449	25	7.5	0.375	0.50	Brown
SFD-1140	0.450	0.599	35	8.0	0.375	0.70	Green
SFD-1520	0.600	0.770	38	8.0	0.500	1.40	Purple
SFD-1960	0.771	0.858	38	8.0	0.500	1.40	Red
SFD-2220	0.859	0.970	40	8.0	0.500	1.50	Orange
SFD-2460	0.971	1.121	40	8.0	0.500	1.50	Pink
SFD-2700	1.122	1.306	40	8.0	0.500	2.00	Gray*
SFD-3035	1.307	1.530	46	8.0	0.500	2.00	Black

\*Gray is the standard color. For yellow, add "-Y" after the catalog number.

Add suffix -B to the catalog number for black semi-conductive layer for applications @ 230kV (i.e.: SFD-2460-B).

The SWAN-FLIGHT Diverter should not be applied on phase conductors energized at voltages of 345kV and above.



## RAPTOR CLAMP™ Diverter, OWL, and RAPTOR CLAMP™ LED Diverter

The **RAPTOR CLAMP™ Diverter** and **OWL** are alternatives to the BIRD-FLIGHT Diverter and the SWAN-FLIGHT Diverter in making overhead power lines visible to birds of all sizes. They provide cost beneficial means of reducing hazards to both power lines and birds. For low and medium voltage construction up to 40 kV, they can be applied to phase conductors (bare or jacketed). For higher voltages, they are usually installed on the overhead shield wire.

The yellow flapper is injection molded, UV stabilized plastic, while the attachment clamp is constructed of high strength UV stabilized engineered composite plastic for maximum strength and clamping force. All fasteners and springs are grade 316 stainless steel.



RAPTOR CLAMP  
Diverter



OWL



RAPTOR CLAMP  
LED Diverter



# RAPTOR CLAMP™ Diverter, OWL, and RAPTOR CLAMP™ LED Diverter



**RAPTOR CLAMP Diverter, RAPTOR CLAMP™ LED Diverter and OWL**

PLP Catalog Number	Diameter Range (In)		Weight (lbs)
	Min	Max	
RAPTOR-Y	0.1	1.5	0.40
RAPTOR-LED	0.1	1.5	1.10
OWL-0445	0.175	0.249	1.10
OWL-0635	0.250	0.349	1.10
OWL-0890	0.350	0.449	1.20
OWL-1140	0.450	0.599	1.70
OWL-1520	0.600	0.700	1.70





## BIRD PERCH DETERRENT™



The **BIRD PERCH DETERRENT (BPD)** is designed to eliminate roosting areas on structures that are electrocution hazards or over equipment to keep it free from bird contamination. BIRD PERCH DETERRENTS provide an economical means of reducing avian fatalities, line outages and equipment flashovers while being easily installed over the structural support.

The BIRD PERCH DETERRENT is lightweight, offers little wind resistance and is quickly installed without the need for attachment hardware. The deterrents are designed to lock into place, preventing any movement on the structure. The BIRD PERCH DETERRENT is manufactured from outdoor grade polyvinyl chloride (PVC) possessing excellent chemical resistance and strength properties and will retain good physical characteristics over a range of



extreme temperatures. Industrial fumes and salt water won't degrade these properties.

A minimum of two BIRD PERCH DETERRENTS are required to ensure proper application. Each has approximately an 8" spacing between the uprights. To calculate the number of BIRD PERCH DETERRENTS required, measure the distance to be covered and divide by 8".

# BIRD PERCH DETERRENT™

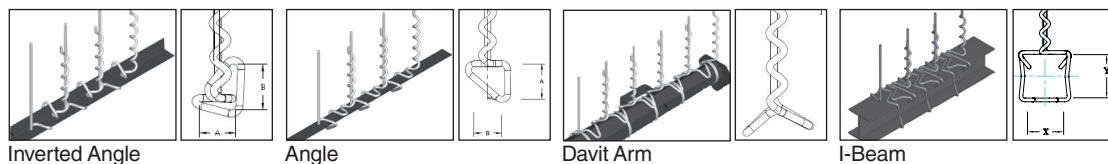

BIRD PERCH DETERRENT			
PLP Catalog Number	Description	Crossarm Dimensions w x h Inches (cm)	Carton Qty
BPD-XARM	BIRD PERCH DETERRENT Crossarm	3.25"w x 4.25"h (8.3 x 10.8 cm)	16
BPD-A22	BIRD PERCH DETERRENT Angle	2"w x 2"h (5.0 x 5.0 cm)	24
BPD-IA22	BIRD PERCH DETERRENT Inverted Angle	2"w x 2"h (5.0 x 5.0 cm)	24
BPD-A25	BIRD PERCH DETERRENT Angle	2.5"w x 2.5"h (6.3 x 6.3 cm)	24
BPD-IA25	BIRD PERCH DETERRENT Inverted Angle	2.5"w x 2.5"h (6.3 x 6.3 cm)	24
BPD-A225	BIRD PERCH DETERRENT Angle	2"w x 2.5"h (5.0 x 6.3 cm)	24
BPD-IA225	BIRD PERCH DETERRENT Inverted Angle	2"w x 2.5"h (5.0 x 6.3 cm)	24
BPD-W6I	BIRD PERCH DETERRENT I-Beam	6"w x 6"h (15.2 x 15.2 cm)	16
BPD-W10I	BIRD PERCH DETERRENT I-Beam	10"w x 10"h (25.4 x 25.4 cm)	16
BPD-HD64	BIRD PERCH DETERRENT Heavy Duty Crossarm	6"w x 4"h (15.2 x 10.2 cm)	16
BPD-HD55	BIRD PERCH DETERRENT Heavy Duty Crossarm	5"w x 5"h (12.7 x 12.7 cm)	16
BPD-DAVIT	BIRD PERCH DETERRENT Davit Arm	Universal	24
BPD-HD3585	BIRD PERCH DETERRENT Heavy Duty Crossarm	3-1/2"w x 8-1/2"h (8.8 x 8.8 cm)	16
BPD-HD5777	BIRD PERCH DETERRENT Heavy Duty Crossarm	5-3/4"w x 7-3/4"h (14.6 x 14.6 cm)	16

**NOTE:** BIRD PERCH DETERRENT'S should not be used if nesting of large birds is prevalent. Yellow versions are available – contact PLP.





# APPLICATION PROCEDURES

## FEATURED PRODUCTS:

**SP3065** RAPTOR PROTECTOR™ for Single & Double Insulator Supports

**SP3203** RAPTOR PROTECTOR™ Articulating Angle

**SP3155** RAPTOR PROTECTOR™ Horizontal Trunnion

**SP3156** RAPTOR PROTECTOR™ Vertical Trunnion

**SP3204** RAPTOR PROTECTOR™ Dead-end Cover

**SP2805** BIRD-FLIGHT™ Diverters

**SP3053** BIRD-FLIGHT™ Aluminum Diverters

**SP3081** SWAN-FLIGHT™ Diverters

**SP3143** BIRD PERCH DETERRENT for Structural Steel

**SP3189** BIRD PERCH DETERRENT for Distribution Crossarms

**SP3196** BIRD PERCH DETERRENT for Inverted Structural Steel

**SP3219** BIRD PERCH DETERRENT for I-Beams

**SP2759** Bushing Cover (WP-2.25F)

**SP2959** Bushing Cover (WP-11S, WP-CSP, WP10T, WP-17T)

**SP2824** Protector Tubing

**SP3093** POLE PLUG

**SP3371** RAPTOR CLAMP™ LED Diverter and RAPTOR CLAMP™  
Diverter-Y

**SP3372** OWL Series

**SP3418** RAPTOR™ Platform for Side-of-Pole Mounting Applications

**SP3419** RAPTOR™ Platform for Top-of-Pole Mounting Applications

**SP3420** RAPTOR™ Platform for Extended Top Pole Mounting Applications

**Application Procedures are available on [www.prefomed.com](http://www.prefomed.com).**

Easily find products by searching the product name or SP number.

---

**JERRY LIGUORI, photographer and author,** has authored three books on raptor identification; **Hawks From Every Angle, Hawks at a Distance** (Princeton Univ. Press, NJ), and **The Crossley ID Guide: Raptors** (Crossley Books, NJ with R. Crossley and B. Sullivan). His accomplishments include numerous articles on raptors, and he has conducted research regarding all aspects of raptor biology, life history, identification, and general behavior. He is active with Hawkwatch International. His studies have taken him across most of North America, researching raptor biology, life history, identification, migration, and general behavior. . . . And taking beautiful photographs.



**PREFORMED**  
LINE PRODUCTS

Global Headquarters  
660 Beta Drive  
Cleveland, Ohio 44143

Mailing Address:  
P.O. Box 91129  
Cleveland, Ohio 44101

Telephone: 440.461.5200  
Fax: 440.442.8816  
Website: [preformed.com](http://preformed.com)  
Email: [inquiries@preformed.com](mailto:inquiries@preformed.com)

© 2018 Preformed Line Products  
Printed in U.S.A.  
EN-ML-1195-3  
04.18.IH