

**COYOTE® SPLICE CASE (STAINLESS STEEL)
 FOR UNDERGROUND, AERIAL, AND BURIED SPLICES
 (6.5", 8.0" AND 9.5" VERSIONS)**

Be sure to read and completely understand this procedure before applying product. Be sure to select the proper PREFORMED™ product before application.

| CONTENTS | PAGE | CONTENTS | PAGE |
|--|-----------|---|-------------|
| 1. NOMENCLATURE | 2,3,4,5,6 | 12. STORING AND/OR ROUTING FIBERS TO BE SPLICED | 12,13 |
| 2. DESCRIPTION | 6 | 13. SECURING TRANSPORT TUBES AND ROUTING FIBERS IN SPLICE TRAYS | 13,14,15,16 |
| 3. DETERMINING BLADE SIZE AND LOCK-TAPE™ SEALANT REQUIREMENTS | 6,7 | 14. SPLICE TRAY STORAGE AND TRANSPORT TUBE OR BUFFER TUBE ROUTING | 16 |
| 4. END PLATE PREPARATION— CUTTER SET-UP | 7 | 15. INSTALLING THE SPLICE CASE USING LOCKBAR™ FASTENING | 17 |
| 5. END PLATE PREPARATION— DRILLING | 7,8 | 16. UNDERGROUND INSTALLATION | 17,18 |
| 6. END PLATE PREPARATION— LOCK-TAPE SEALANT APPLICATION | 8 | 17. AERIAL INSTALLATION | 18 |
| 7. CABLE PREPARATION— APPLYING LOCK-TAPE TO CABLES FOR FIELD-DRILLED END PLATES | 9 | 18. EXTERNAL BONDING PROCEDURE | 18 |
| 8. END PLATE ASSEMBLY— CABLES ENTERING THROUGH FIELD-DRILLED HOLES | 9,10 | 19. RE-ENTRY PROCEDURE | 18 |
| 9. BONDING AND/OR GROUNDING CABLES WITH METALLIC COMPONENTS | 10 | 20. MAINTENANCE PROCEDURES | 18,19 |
| 10. INSTALL ORGANIZER ASSEMBLY .. | 10,11 | 21. MEASURING CABLE FOR OLD TYPE POWER END PLATE CUTTER AND BLADE KIT | 19 |
| 11. ROUTING AND SECURING UNITUBE CABLE FIBERS AND ROUTING BUFFER TUBES | 11,12 | 22. SAFETY CONSIDERATIONS | 19 |

1.00 NOMENCLATURE

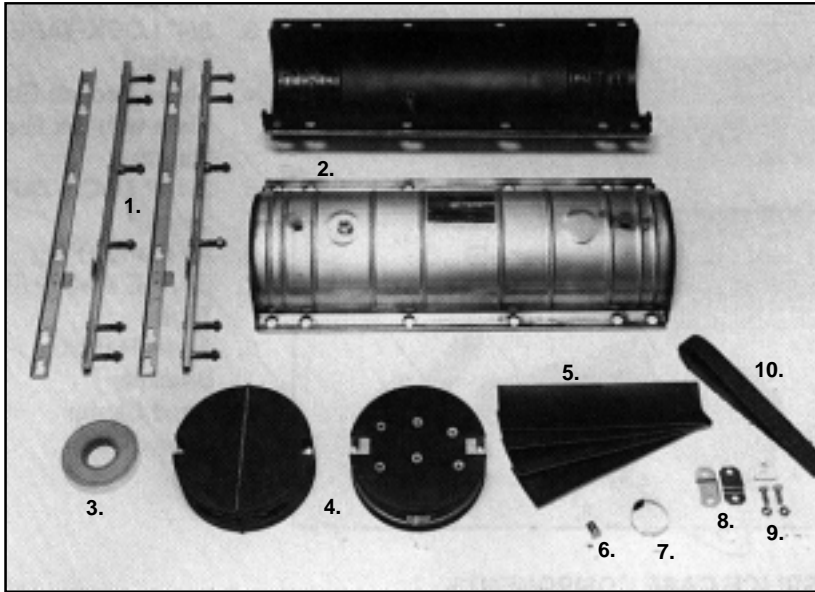

1. LOCKBAR Fasteners
2. Stainless Steel Shell Halves
3. 3/4" LOCK-TAPE Sealant
4. End Plates
5. LOCK-TAPE Sealant Strips
6. Air Flange Plug
7. CABLE Mea-SURE™ Tape
8. Aerial Hanging Brackets
9. Bond Clamp
10. Emery Cloth

**FIGURE 1 – COYOTE SPLICE CASE COMPONENTS
(TYPICAL)**

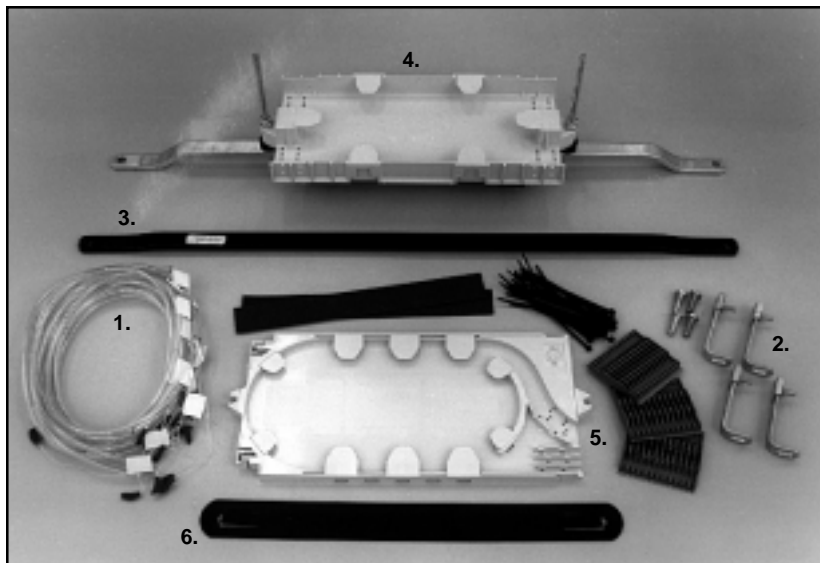

1. Transport Tubes
2. "L" Brackets ⁽¹⁾
3. Torque Bar
4. Transition Compartment with Torque Bar
5. Splice Tray Kit with Clear Cover, Elastomer Splice Blocks, Felt Strips and Tie Wraps ⁽²⁾
6. Splice Tray Hold Down Strap

NOTES:

1. These items sold with DLX Splice Cases only.

2. Splice Trays sold separately, except Splice Tray #80805146 is supplied with Splice Cases #8006525, #8006526, #8006527 and #8006528.

**FIGURE 2 – TRANSITION ASSEMBLY
AND RELATED COMPONENTS
(TYPICAL FOR UNITUBE VERSIONS)**

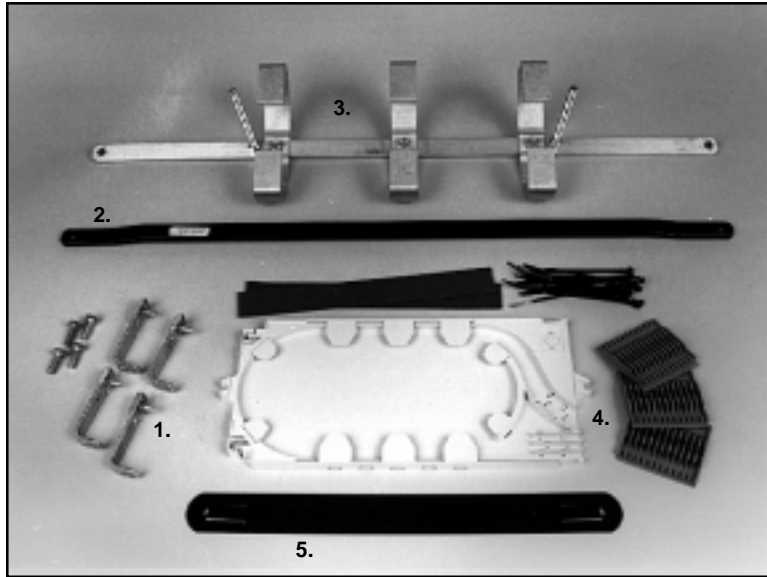

1. "L" Brackets ⁽¹⁾
2. Torque Bar
3. Buffer Tube Storage Assembly with Torque Bar
4. Splice Tray Kit with Clear Cover, Elastomer Splice Blocks, Felt Strips and Tie Wraps ⁽²⁾
5. Splice Tray Hold Down Strap

NOTES:

1. These items supplied with DLX Splice Cases only.
2. Splice Trays sold separately.

**FIGURE 3 – BUFFER TUBE STORAGE ASSEMBLY
AND RELATED COMPONENTS
(TYPICAL, EXCEPT 9.5" X 45")**

COYOTE SPLICE CASES

| Catalog Number | Description |
|---|--|
| 8006526 (with tray) 8006550 (without tray) | 6.5" x 22" (for unitube applications, butt splice only), includes one (1) Two-Section End Plate, one (1) Three-Section End Plate, one (1) Transition Assembly, and one (1) Transport Tube Kit and one (1) Splice Tray (80805146). |
| 8006525 (with tray) 8006551 (without tray) | 6.5" x 22" DLX (for unitube applications, butt splice only), includes one (1) Two-Section End Plate, one (1) Three-Section End Plate with six grounding inserts, one (1) Transition Assembly, one (1) Transport Tube Kit, four (4) "L" Brackets, and one (1) Splice Tray (80805146). |
| 8006615 | 6.5" x 22" (for buffer tube applications), includes one (1) Two-Section End Plate (assembled), one (1) Three-Section End Plate, and one (1) Storage Assembly. |
| 8006616 | 6.5" x 22" DLX (for buffer tube applications), includes one (1) Two-Section End Plate (assembled), one (1) Three-Section End Plate with six grounding inserts, one (1) Storage Assembly, and four (4) "L" Brackets. |
| 8006528 (with tray) 8006552 (without tray) | 6.5" x 28" (for unitube applications), includes one (1) Two-Section End Plate (assembled), one (1) Three-Section End Plate, one (1) Transition Assembly, and one (1) Transport Tube Kit, and one (1) Splice Tray (80805146). |
| 8006527 (with tray) 8006553 (without tray) | 6.5" x 28" DLX (for unitube applications), includes one (1) Two-Section End Plate (assembled), one (1) Three-Section End Plate with six grounding inserts, one (1) Transition Assembly, one (1) Transport Tube Kit, four (4) "L" Brackets, and one (1) Splice Tray (80805146). |
| 8006617 | 6.5" x 28" (for buffer tube applications), includes one (1) Two-Section End Plate, one (1) Three-Section End Plate, and one (1) Storage Assembly. |
| 8006618 | 6.5" x 28" DLX (for buffer tube applications), includes one (1) Two-Section End Plate, one (1) Three-Section End Plate with six grounding inserts, one (1) Storage Assembly, and four (4) "L" Brackets. |
| 8006656 | 6.5" x 28" DLX EXPRESS VERSION (for buffer tube applications), includes one (1) Two-Section End Plate, one (1) Three-Section End Plate with six grounding inserts, one (1) Express Buffer Tube Storage Assembly, and four (4) "L" Brackets. |
| 8006625 | 8" x 28" DLX (for unitube applications), includes one (1) Two-Section End Plate, one (1) Three-Section End Plate with six grounding inserts, one (1) Transition Assembly, one (1) Transport Tube Kit, and four (4) "L" Brackets. |
| 8006626 | 8" x 28" DLX (for buffer tube applications), includes one (1) Two-Section End Plate, one (1) Three-Section End Plate with six grounding inserts, one (1) Buffer Tube Storage Assembly, and four (4) "L" Brackets. |
| 8006657 | 9.5" x 28" DLX (for unitube applications), includes one (1) Two-Section End Plate, one (1) Three-Section End Plate with six grounding inserts, one (1) Transition Assembly, one (1) Transport Tube Kit and four (4) "L" Brackets. |
| 8006627 | 9.5" x 28" DLX (for buffer tube applications), includes one (1) Two-Section End Plate, one (1) Three-Section End Plate with six grounding inserts, one (1) Buffer Tube Storage Assembly and four (4) "L" Brackets. |
| 8006628 | 9.5" x 45" DLX (for buffer tube applications), includes one (1) Two-Section End Plate, one (1) Three-Section End Plate with six grounding inserts, one (1) Dual Buffer Tube Storage Assembly and four (4) "L" Brackets. |

SPLICE CAPACITIES

| 6.5" x 22" and 6.5" x 28" COYOTE Splice Cases * | | | | | |
|---|---------------------------|------------------------------------|--------------------------|----------------------------------|------------------------------|
| Catalog Number | Description | Useable Connectors | Splice Capacity Per Tray | Maximum No. of Trays Per Closure | Max. Closure Splice Capacity |
| 80805110 | 36-Count Rigid Block | Protected Fusion Single Mechanical | 36 | 4 | 144 |
| 80805514 | 36-Count Elastomer Blocks | Protected Fusion Single Mechanical | 36 | 4 | 144 |
| 80805146 | Ribbon Fiber Splice Tray | 3M Mass Connector | 96 | 2 | 192 |
| | | Protected Mass Single Mechanical | 144 | 2 | 288 |
| 8" x 28" COYOTE Splice Case | | | | | |
| Catalog Number | Description | Useable Connectors | Splice Capacity Per Tray | Maximum No. of Trays Per Closure | Max. Closure Splice Capacity |
| 80805110 | 36-Count Rigid Block | Protected Fusion Single Mechanical | 36 | 6 | 216 |
| 80805514 | 36-Count Elastomer Blocks | Protected Fusion Single Mechanical | 36 | 6 | 216 |
| 80805146 | Ribbon Fiber Splice Tray | 3M Mass Connector | 96 | 4 | 384 |
| | | Protected Mass Fusion | 144 | 4 | 576 |
| 9.5" x 28" COYOTE Splice Case | | | | | |
| Catalog Number | Description | Useable Connectors | Splice Capacity Per Tray | Maximum No. of Trays Per Closure | Max. Closure Splice Capacity |
| 80805110 | 36-Count Rigid Block | Protected Fusion Single Mechanical | 36 | 10 | 360 |
| 80805514 | 36-Count Elastomer Blocks | Protected Fusion Single Mechanical | 36 | 10 | 360 |
| 80805146 | Ribbon Fiber Splice Tray | 3M Mass Connector | 96 | 6 | 576 |
| | | Protected Mass Fusion | 144 | 6 | 864 |
| 9.5" x 45" COYOTE Splice Case | | | | | |
| Catalog Number | Description | Useable Connectors | Splice Capacity Per Tray | Maximum No. of Trays Per Closure | Max. Closure Splice Capacity |
| 80805110 | 36-Count Rigid Block | Protected Fusion Single Mechanical | 36 | 18 | 648 |
| 80805514 | 36-Count Elastomer Blocks | Protected Fusion Single Mechanical | 36 | 18 | 648 |

*6.5" x 28" Express Version (Cat. No. 8006656) will hold only 50% of the maximum number of trays listed (maximum splice capacity is reduced by one-half).

1.01 The COYOTE Splice Case contains everything needed for installation except hand tools, vinyl tape, filled cable cleaning fluid, and C-Cement.

1.02 Tools Needed:

- Splicer's scissors
- Splicer's knife
- Tabbing shears
- Common screwdriver
- 1/2" deep well socket (6.5" Splice Case)
- 3/8" nutdriver or socket
- Needlenose pliers
- Buffer tube removal tool and/or slitter
- Sidecutters
- Torque Wrench (inch pound readings)*
- Power End Plate Cutter*

*Available from Preformed Line Products

2.00 DESCRIPTION

2.01 For Safety Considerations, refer to Section 22.00 of this procedure.

2.02 The COYOTE Splice Case organizes and distributes unitube and buffer tube type fiber optic cables.

2.03 The COYOTE Splice Case End Plates have the cable capacities as shown in Figure 4.

| | | |
|---|---|---|
| 6.5" THREE-SECTION STANDARD END PLATE |  | 3 ENTRIES PER SEAM MAX. DIA. 1.1" |
| 6.5" DLX END PLATE THREE-SECTION USED ON 22" AND 28" |  | 3 ENTRIES PER SEAM MAX. DIA. .688 (11/16") MAX. DIA. .375 (3/8") |
| ALTERNATE HOLE PATTERN 6.5" DLX END PLATE THREE- SECTION USED ON 22" AND 28" |  | 3 ENTRIES PER SEAM MAX. DIA. .688 (11/16") MAX. DIA. .375 (3/8") |
| 8.0" AND 9.5" DLX THREE-SECTION END PLATE |  | 3 ENTRIES PER SEAM MAX. DIA. 1.1" |

FIGURE 4 – END PLATE CAPACITIES (VIEW FROM INSIDE END PLATE)

NOTE: An additional 1.5" of space is available on each seam for cable entries on the 8.0" COYOTE Splice Case, and an additional 3.0" of space is available on each seam of the 9.5" COYOTE Splice Case. However, provisions for securing the L-Brackets are only provided for the six entries shown in Figure 4.

3.00 DETERMINING BLADE SIZE AND LOCK-TAPE SEALANT REQUIREMENTS

3.01 CABLE Mea-SURE Tape is used to determine the correct Power End Plate Cutter blade size and the required layers of LOCK-TAPE Sealant.

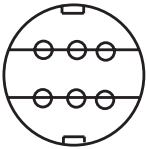
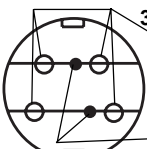
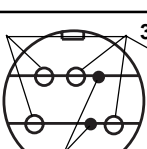
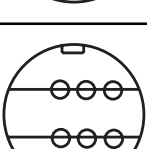
- 3.02** To use CABLE Mea-SURE Tape:
- Wrap it around the cable tightly. (Figure 5)
 - The index line will point to a letter and number.
 - The letter indicates the correct blade size.
 - The number indicates the correct number of layers of half-lapped LOCK-TAPE Sealant. (Figure 5)

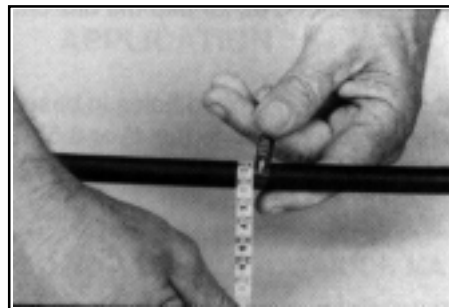

FIGURE 5 – WRAP CABLE MEA-SURE TAPE AROUND CABLE

NOTE: Follow the procedures per paragraph 3.02 for ADSS cable. For OPGW application, measure the OPGW per paragraph 3.02 and follow the procedures for the green sealant moisture block included in the Green Sealant Kit (Cat. No. 8003411).

NOTE: If the index line falls on a line between two numbers, always use the number to the right of the line. (Figure 6)

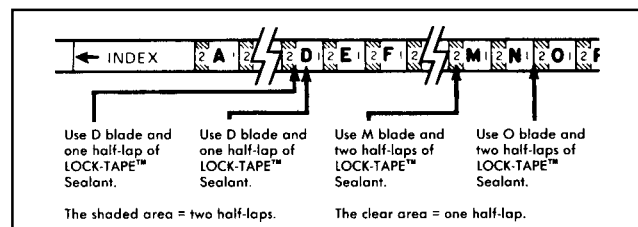

FIGURE 6 – SKETCH OF MEASURE TAPE

CAUTION: Cable may vary in diameter from place to place along its length, so be sure to measure each cable at the area where the End Plate is to be placed.

NOTE: If still using old cutter with Fiber Measure Tape, refer to Section 21.00 for instructions.

4.00 END PLATE PREPARATION – CUTTER SET-UP

4.01 When using blades A-D, install the blade directly into chuck. For blades E-DD, first install blade into the drill adapter.

4.02 Secure blade or adapter into drill chuck. Tighten drill chuck in all three locations.

CAUTION: To prevent blades from coming in contact with base of Power End Plate Cutter, insure that blade or adapter is inserted as far into the drill chuck as possible.

4.03 Insert stop-posts in tapped holes in base of cutter corresponding to the 6.5", 8.0" or 9.5" End Plate diameter and hand tighten firmly. (Figure 7)

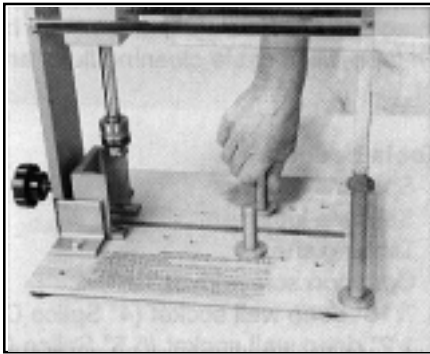

FIGURE 7 – PUT STOP POSTS INTO CUTTER

5.00 END PLATE PREPARATION – DRILLING

5.01 Locate the designated drill marks on the End Plate (highlighted in yellow). These marks should face up when placing End Plate in Power End Plate Cutter. (Figure 8)

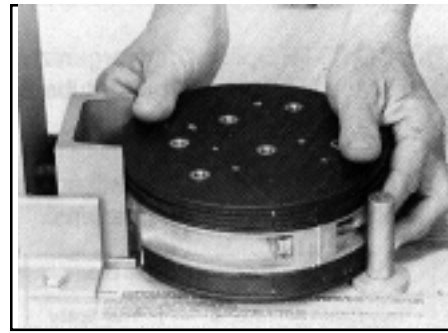

FIGURE 8 – END PLATE SHOWING THE DESIGNATED DRILL MARKS

5.02 To enable bonding/strain relief brackets to be properly applied, the cable entry holes **must** be drilled at the designated drill marks highlighted in yellow.

5.03 To position End Plate in the cutter:

- Rotate End Plate and slide bearing block along the guides until the drill is positioned over designated drill marks.

- Then, tighten the clamp screw and thumb screw on the bearing block. (Figure 9)

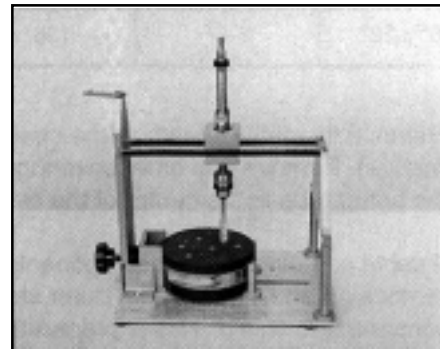

FIGURE 9 – BLADE POSITIONED

CAUTION: The thumb screws in the bearing block are backed up by a small nylon pellet. Using cutter with pellet missing could cause damage to the guide rails.

To prevent damage, remove the thumb screws and insert a small piece of cable sheath. Additional nylon pellets are available from PLP®.

5.04 Mount a 3/8" drill, drill blade adapter, and one 1/2" deep well socket to the upper end of the bearing block shaft.

5.05 Drill through the End Plate until the shaft bottoms out on the stop collar. **When the drill has bottomed out, stop the drill.**

CAUTION: Never bring the blade back up while it is still turning. This could result in an oversized hole. Do not exert sideways pressure on drill shaft, it may cause damage to the bearing block.

5.06 If additional holes are needed, repeat preceding steps 4.00-5.05. (Figure 10)

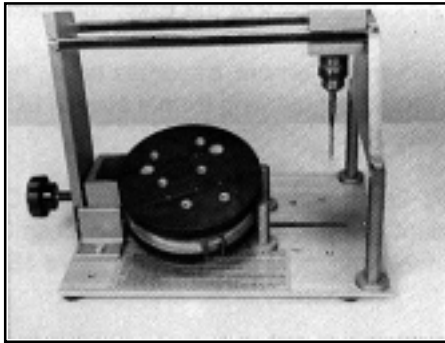

FIGURE 10 – END PLATE WITH HOLES DRILLED

5.07 Remove the End Plate from the cutter and disassemble End Plates by removing both bolts.

6.00 END PLATE PREPARATION – LOCK-TAPE SEALANT APPLICATION

6.01 Remove sharp edges on plastic and foam in area of opening with emery cloth (provided). (Figure 11)

**SCUFF LIGHTLY.
DO NOT REMOVE TOO MUCH MATERIAL.**

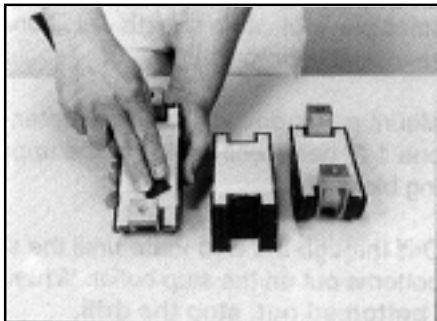

FIGURE 11 – SCUFFING CABLE OPENINGS

PLP TIP: This simple operation will help prevent catching the LOCK-TAPE Sealant when drawing the End Plates together. ONLY USE EMERY CLOTH PROVIDED FOR THIS PROCEDURE.

6.02 Apply a thin coat of C-Cement to each inside surface of the End Plate sections.

6.03 When C-Cement becomes tacky, remove protective backing from a strip of LOCK-TAPE Sealant.

PLP TIP: Use removed backing from a LOCK-TAPE Sealant strip to dry and remove excess C-Cement applied to End Plate. (Figure 12)

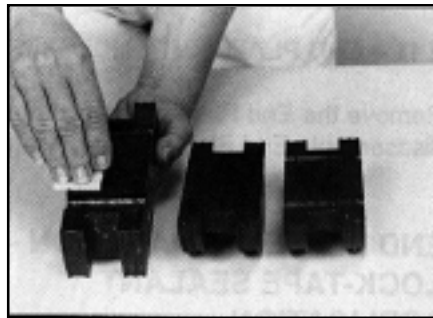

FIGURE 12 – C-CEMENT ON END PLATE

6.04 Without stretching, apply LOCK-TAPE Sealant over prepared surface of the End Plates, following the contour of the cable holes.

Allow approximately 3/4" of LOCK-TAPE Sealant to extend beyond each end of the End Plate. This will serve as a tightening indicator during the End Plate assembly.

6.05 Square cut the tape away from the bolt holes. (The area just beyond the metal insert.) (Figure 13)

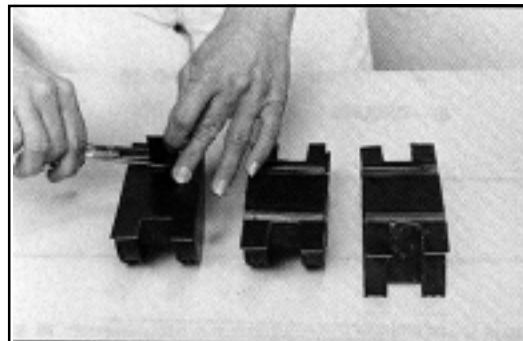

FIGURE 13 – SQUARE CUT BOLT HOLES

7.00 CABLE PREPARATION – APPLYING LOCK-TAPE SEALANT TO CABLES FOR FIELD-DRILLED END PLATE

7.01 Measure and mark cables for sheath openings:

| Closure | Continuous Length | Cut Cables |
|------------|-------------------|------------|
| 6.5" x 22" | 248" | 124" |
| 6.5" x 28" | 276" | 138" |
| 8.0" x 28" | 280" | 140" |
| 9.5" x 28" | 288" | 144" |
| 9.5" x 45" | 356" | 178" |

NOTE: For OPGW applications, a separate Green Sealant Kit (Cat. No. 8003411) must be ordered for each Splice Case. Follow the procedures provided with this kit to prepare the OPGW.

7.02 Remove the cable sheath to the opening mark(s). Remove any other coverings to expose the central tube or buffer tubes in the center of the cable.

7.03 If cable contains metallic components, remove an additional 1/2" of outer sheath exposing the metallic shield. This is preparation for bonding and grounding.

7.04 Remove moisture block tape and any other materials from exposed tube.

7.05 Mark the cable 1.5" and 5.5" outward from cable opening with metallic components and at 4" outward from the cable opening for dielectric cables. Using the emery cloth provided, scuff the cable between the marks for cables with metallic components or up to the marks for dielectric cables. Always scuff around the cable, never scuff lengthwise.

7.06 Coat the scuffed area of cable with C-Cement and allow to dry to tacky base.

7.07 Apply required number of half-lapped layers of 3/4" LOCK-TAPE Sealant around the cable in the area coated with C-Cement. Stretch tape while applying. (Figure 14)

PLP TIP: Stretch tape enough to reduce its width to 1/2". Figure 15 shows the completed application of one half-lapped layer of LOCK-TAPE Sealant.

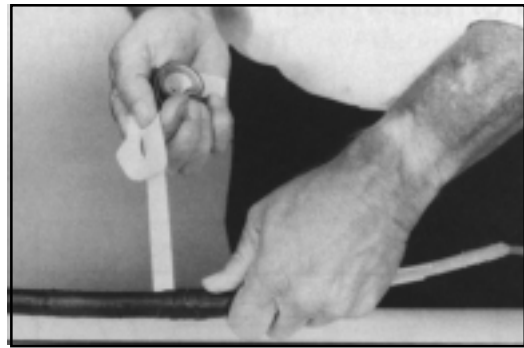

FIGURE 14 – APPLYING LOCK-TAPE SEALANT

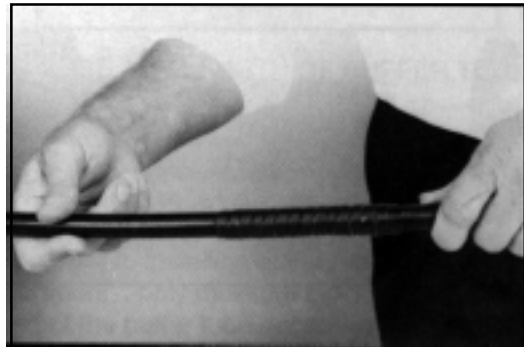

FIGURE 15 – COMPLETED LOCK-TAPE SEALANT APPLICATION

8.00 END PLATE ASSEMBLY CABLES ENTERING THROUGH FIELD-DRILLED HOLES

8.01 Using the hex bolts provided, fasten the "L" bracket and retaining clip to the End Plate.

8.02 Before installing prepared cables into the End Plate halves, apply 1/4" wide bead of C-Cement adjacent to the drilled hole. (Figure 16)

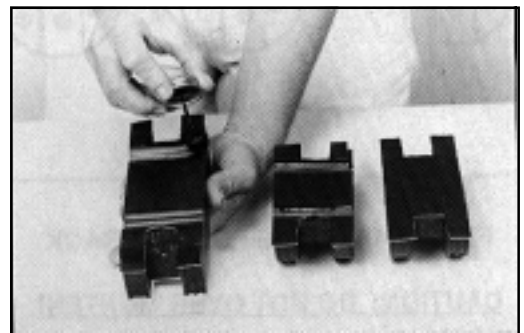

FIGURE 16 – BRUSH C-CEMENT OVER LOCK-TAPE SEALANT

NOTE: If cables being placed in End Plate require bonding and/or grounding, review Section 9.00 before installing End Plate.

8.03 Position prepared cables into the lower End Plate section, allowing 1/2" of the LOCK-TAPE Sealant to extend beyond the inside of the End Plate. THIS IS A CRITICAL MEASUREMENT.

8.04 For cables containing non-metallic strength members, insert strength members into retainer clip and tighten. Cut off excess strength member.

8.05 Where applications dictate, position prepared cables into the upper End Plate seam per step 8.03 and insert End Plate bolts.

8.06 Using a socket and ratchet, tighten each bolt evenly in rotation 2 or 3 turns at a time.

CAUTION: Do not use power tools for this operation.

8.07 While tightening, the excess LOCK-TAPE Sealant extending from the End Plate section will fold back. When the LOCK-TAPE Sealant stops moving (folds back), the bolts are sufficiently tight. (Figure 17)

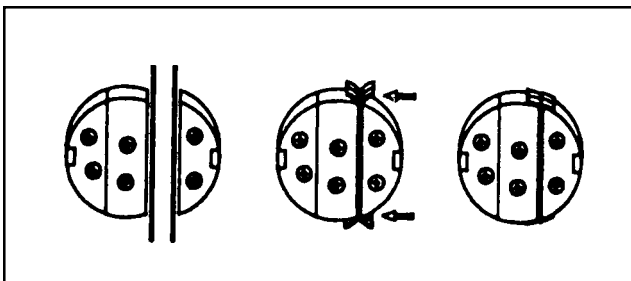

FIGURE 17 – TAPE FOLDING BACK

CAUTION: DO NOT OVER TIGHTEN!

8.08 Trim excess LOCK-TAPE Sealant to within 1/8" of End Plate. **DO NOT STRETCH TAPE DURING TRIMMING PROCESS.**

9.00 BONDING AND/OR GROUNDING CABLE WITH METALLIC COMPONENTS

NOTE: Installation of bonding and grounding components may be easier if installed prior to placing cables into End Plate.

9.01 If cable contains a metallic shield, install shield connector and/or bonding assembly per company specifications.

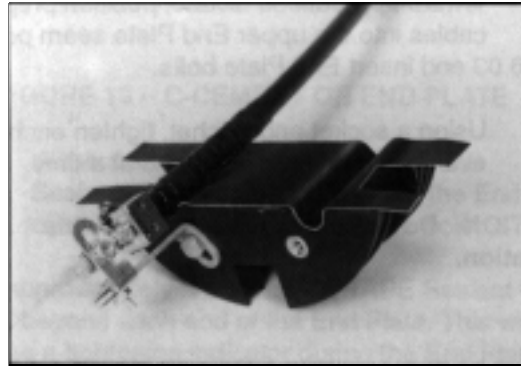

FIGURE 18 – AT&T BONDING ASSEMBLY

9.02 Use one of the small "L" shaped brackets and attach shield connector and/or bonding assembly to the retainer clip of the previously installed large "L" bracket (see Paragraph 8.01).

9.03 If cable contains a strength member, insert the strength member into the retainer clip and tighten. Cut off excess strength member.

10.00 INSTALL ORGANIZER ASSEMBLY

10.01 Remove the torque bar attachment bolt from the End Plate and secure the Transition Assembly Torque Bar or Buffer Tube Storage Assembly Torque Bar to the End Plate. (Figures 19A & 19B)

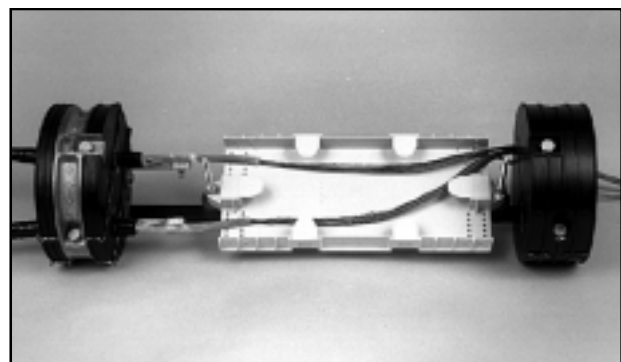

FIGURE 19A – TRANSITION ASSEMBLY SECURED TO END PLATES (6.5" X 22" DLX SHOWN)

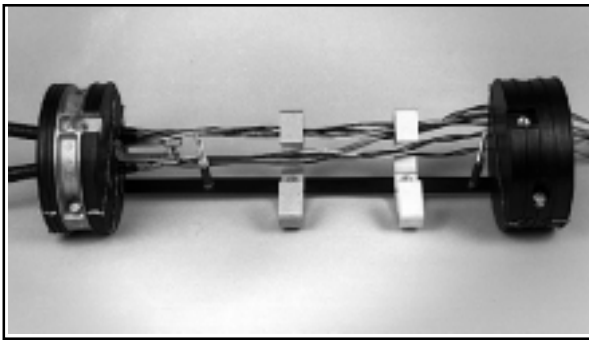

FIGURE 19B – BUFFER TUBE STORAGE ASSEMBLY SECURED TO END PLATES (6.5" X 22" DLX SHOWN)

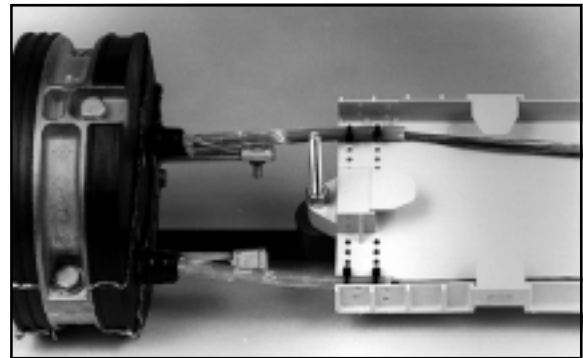

FIGURE 21 - CENTRAL TUBE SECURED IN TRANSITION COMPARTMENT (6.5" X 22" DLX SHOWN)

11.00 ROUTING AND SECURING UNITUBE CABLE FIBERS AND ROUTING BUFFER TUBES

- 11.01** Place a tape marker on the central tube of unitube-type cables as shown in Figure 20.

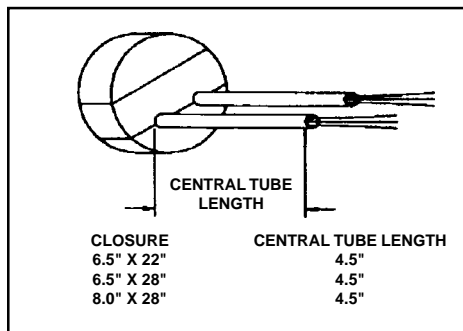

FIGURE 20 – LENGTH OF BUFFER TUBE

- 11.02** Remove the central tube to the mark and thoroughly clean the fibers using company approved methods.

NOTE: Prior to installing the central tube in transition compartment, apply moisture blocking sealant into the end of the buffer tube according to company or manufacturer's practices.

- 11.03** Use the tie wraps provided to secure the two (2) main cables to the outside tie down locations of the transition compartment. (Figure 21)

CAUTION: USE CARE WHEN HANDLING EXPOSED FIBER

NOTE: When securing the central tube, always apply two tie wraps.

- 11.04** If a third cable (branch cable) is used, secure the central tube or buffer tubes as close as possible to one of the main cables.

- 11.05** If the upper End Plate seam is needed for additional branch cables, reduce the length of the buffer tube to 5/8" beyond the cable jacket. (Figure 22)

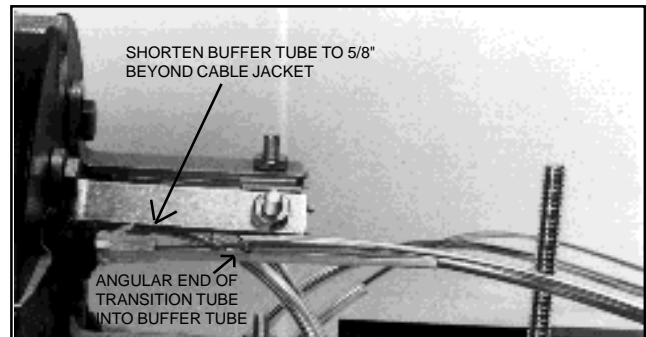

FIGURE 22 – SHORTENED BUFFER TUBE WITH PLACED ANGULAR END OF TRANSITION TUBE

- 11.06** Using Transition Tubing (available from PLP®, cat. #8003280), make an angular cut at the end where the fiber will be inserted and wrap one layer of felt tape 1/2" in from the opposite end of the tube. (Figure 22)

NOTE: Before placing the fiber into the transition tube, check that no burrs are present on the I.D. of the buffer tube. If burrs are present, carefully remove or gently press the burrs outward.

11.07 Insert fiber into the transition tube and slide the tube over the fiber until the angular cut end of the transition tube meets the buffer tube.

11.08 Ease the angular cut end of transition tube into the buffer tube and insert inward for 3/8" to 1/2". (Figure 23)

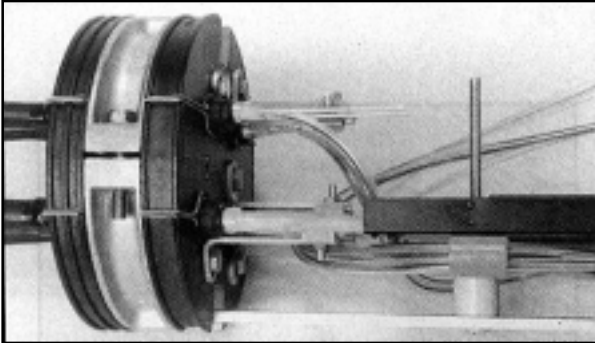

FIGURE 23 – EASE TRANSITION TUBE INTO BUFFER TUBE

11.09 Route transition tubes downward toward the center of the transition compartment, into the clips provided, and secure into the transition compartment as close as possible to one of the main cables.

11.10 Route fibers one and one-half (1-1/2) times around the transition compartment and out. For continuous loop, wrap until all fiber is stored. (Figure 24)

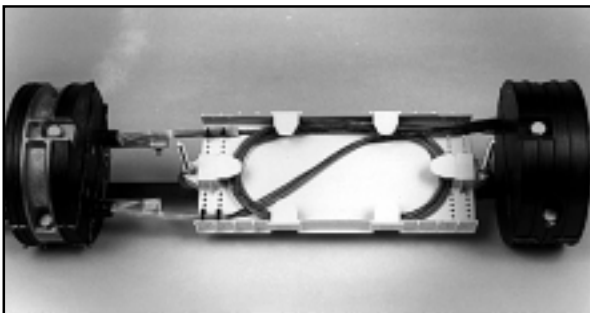

FIGURE 24 – ROUTING FIBERS WITHIN TRANSITION COMPARTMENT (6.5" X 22" DLX SHOWN)

11.11 Route buffer tubes one turn through the buffer tube storage clip as shown in Figure 25.

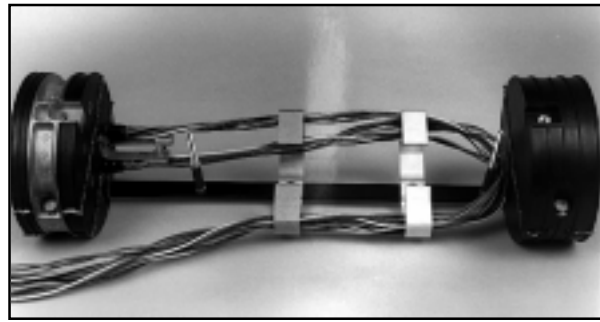

FIGURE 25 – ROUTING BUFFER TUBES WITHIN BUFFER TUBE STORAGE CLIPS (6.5" X 22" DLX SHOWN)

12.00 STORING AND/OR ROUTING FIBERS TO BE SPLICED

NOTE: Fibers of unitube-type cables should be installed into transport tube using pull string contained within the tube; however, for small count fiber groups, it may be easier to push fiber through the tube.

| Transport Tube Lengths for each COYOTE Splice Case | |
|--|-----------------------|
| Splice Case Size | Transport Tube Length |
| 6.5" x 22" | 28" |
| 6.5" x 28" | 34" |
| 8.0" x 28" | 36" |

12.01 On continuous cables only, identify and cut fibers to be spliced at the midpoint in the fiber loop. This will permit splicing in either direction.

12.02 Group fibers into groups of 12 or 18, based on quantity of fibers to be spliced. This will identify the number of required transport tubes.

12.03 Select the required number of transport tubes and wrap one layer of felt tape 1/2" from both ends of the tube. Wrap one layer of felt tape 1/2" from the end of the buffer tubes.

12.04 To feed the fiber through the transport tube, apply the pull string to the fiber with a double half hitch knot.

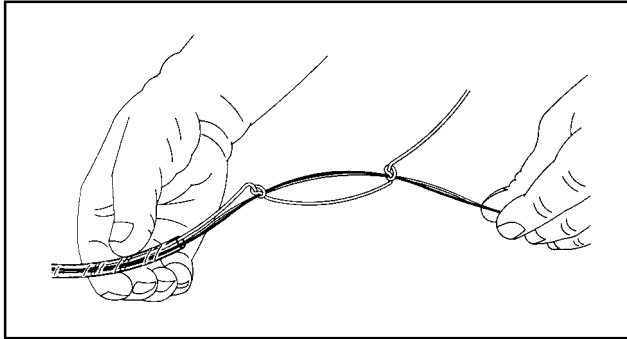

FIGURE 26 – PULL STRING THROUGH TRANSPORT TUBE

12.05 Gently pull the fiber group through the transport tube. (Figure 26)

PLP TIP: The fiber group will feed through the transport tube easier if the transport tube is held as straight as possible during the operation.

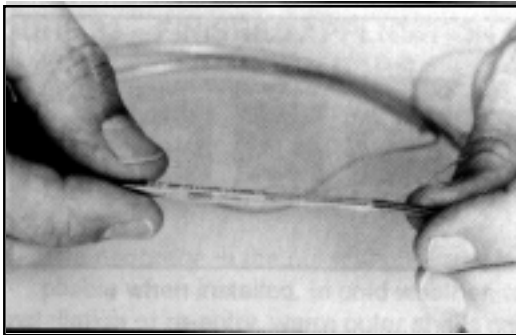

FIGURE 27 – FIBER THROUGH TRANSPORT TUBE

12.06 Complete steps 12.04 and 12.05 for the remaining fiber groups.

12.07 Route transport tubes and secure using the tie wraps provided. Secure all the transport tubes to the inside tie wrap locations. (Figure 28)

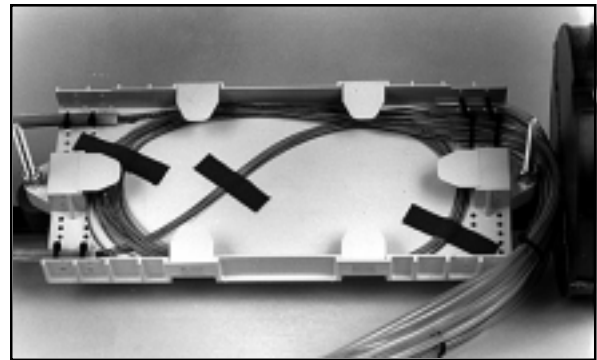

FIGURE 28 – SECURING TRANSPORT TUBES TO TRANSITION COMPARTMENT

13.00 SECURING TRANSPORT TUBES AND ROUTING FIBER IN SPLICE TRAYS

13.01 There are two types of splice trays available for the COYOTE Splice Case. The single fiber trays is designed for single fusion or single mechanical splice applications. The single fiber tray can accommodate up to 36 single fiber splices. The mass fiber tray is designed for 12 mass fusion or 8 mass mechanical splices. (Figure 29)

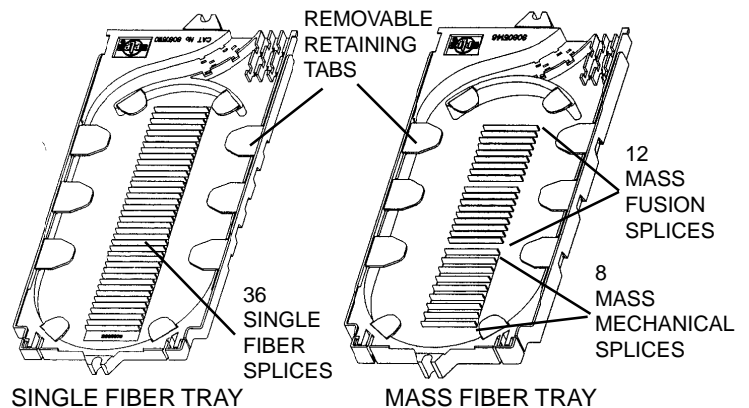

FIGURE 29 - SPLICE TRAYS

13.02 Remove cover of splice tray. (Figure 30)

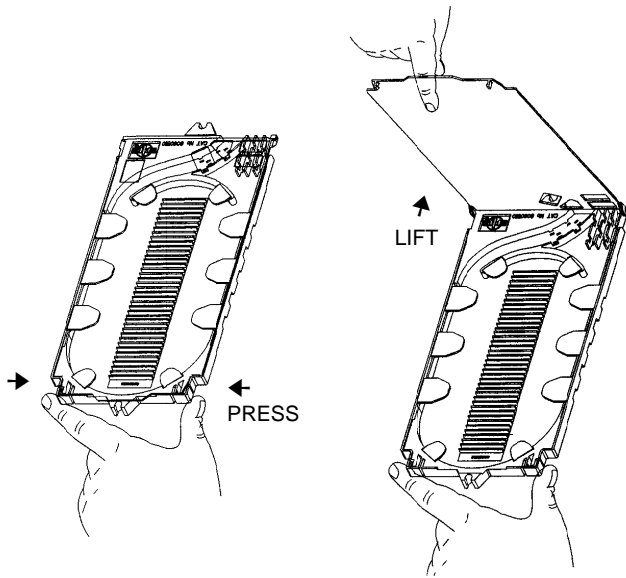

FIGURE 30 - REMOVE SPLICE TRAY COVER

13.03 Position the transport tubes or buffer tubes onto the splice tray so they extend 1/4" (.64 cm) past the tie down holes and apply provided tie wraps as shown in Figures 31 A & B.

PLP TIP: For easy tie wrap installation, insert the tie wrap with the ridges on the inside of the loop, with the head opposite the notch in the splice tray. Insert the tail into the head. Press head down to the tray and hold in place while pulling the tail to tighten the tie wrap.

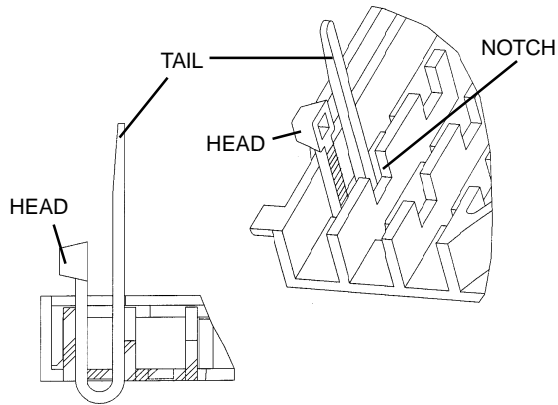

FIGURE 31A - SECURE TIE WRAPS

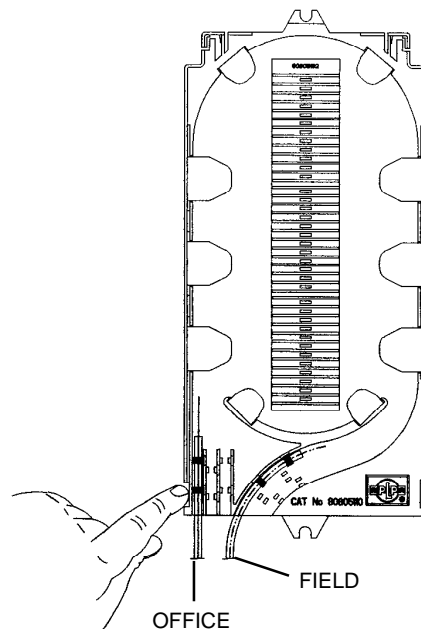

FIGURE 31B - POSITION AND SECURE TRANSPORT TUBES OR BUFFER TUBES

13.04 When routing the fiber in the **SINGLE COUNT SPLICE TRAY**, route fibers **1-24** 1-1/2 times around the splice tray and lay into the top of the splice block (see Figure 32A). Route fibers **25-36** 1-3/4 times around the splice tray, and lay into the bottom of the splice block (see Figure 32B).

NOTE: There should be a minimum of 50" (127 cm) of exposed fiber for splicing.

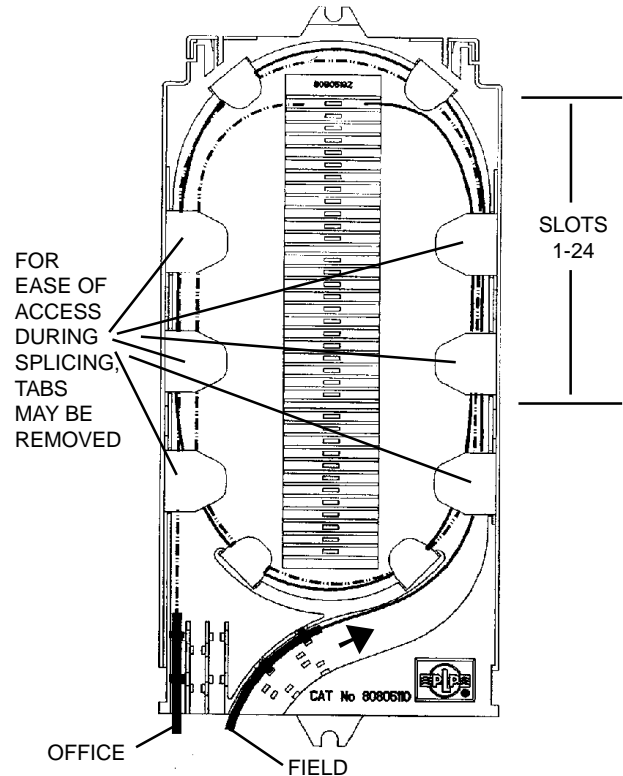

FIGURE 32A - ROUTING FIBERS IN THE SINGLE FIBER SPLICE TRAY—FIBERS 1-24

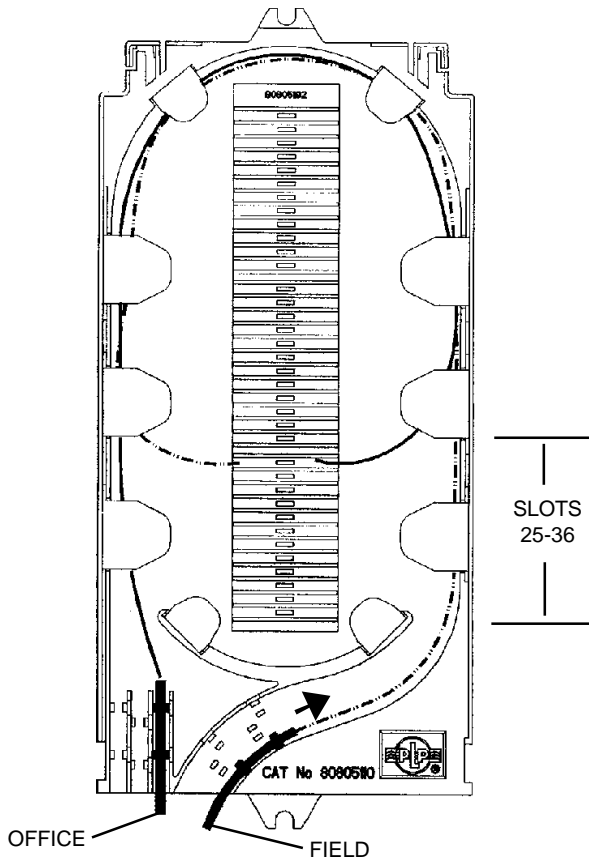

FIGURE 32B - ROUTING FIBERS IN THE SINGLE FIBER SPLICE TRAY—FIBERS 25-36

13.05 Splice the fibers according to your accepted company practices. (Figure 33)

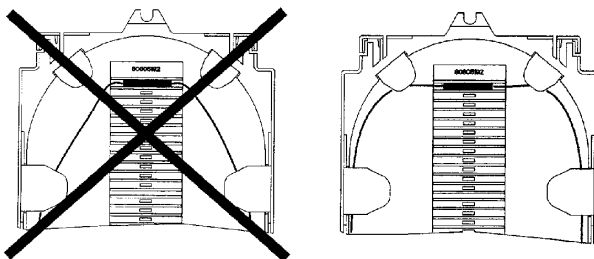

FIGURE 33 - BEND RADIUS - IMPORTANT

PLP TIP: If splice protectors loosely fit in the slots of the splice block, wrap each protector with felt tape to provide the desired fit **or** use a bead of silicone caulk to secure the connectors and place a strip of felt tape over the connectors and silicone caulk. Place Splice Count Label on cover to identify fibers spliced. On the back of both trays, slots are provided to aid in the removal of splice protectors or connectors. (Figure 34)

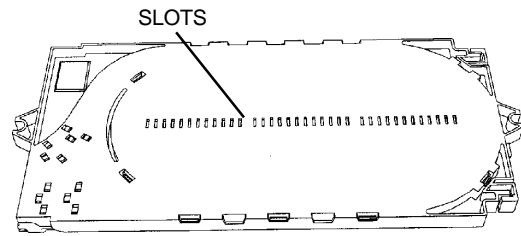

FIGURE 34 - SPLICE BLOCK SLOTS

13.06 When routing the fiber in the **MASS FIBER SPLICE TRAY for MASS MECHANICAL**, route fibers 1-1/2 times around the splice tray and lay into the top of the splice block. (Figure 35)

NOTE: There should be a minimum of 50" (127 cm) of exposed fiber for splicing.

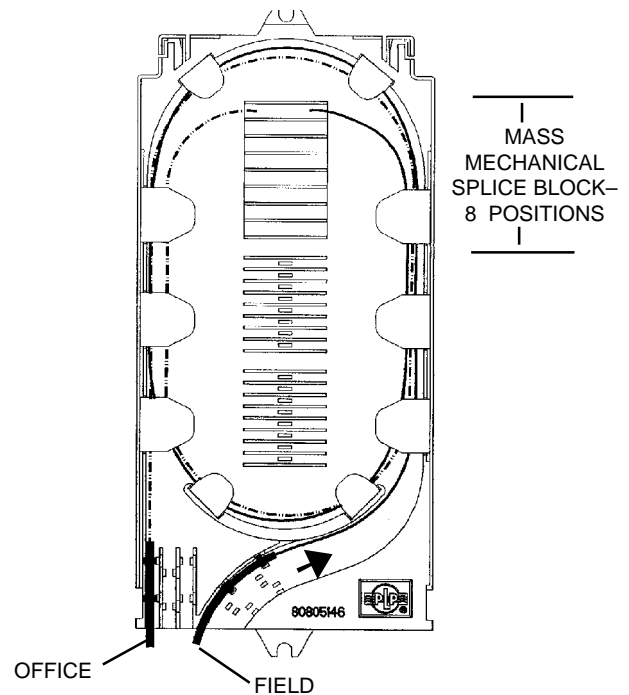

FIGURE 35 - ROUTING FIBERS IN THE MASS FIBER SPLICE TRAY FOR MASS MECHANICAL

13.07 When routing fibers in the **MASS FIBER SPLICE TRAY for MASS FUSION**, route fiber 1-3/4 times around the splice tray and lay into the splice block. (Figure 36)

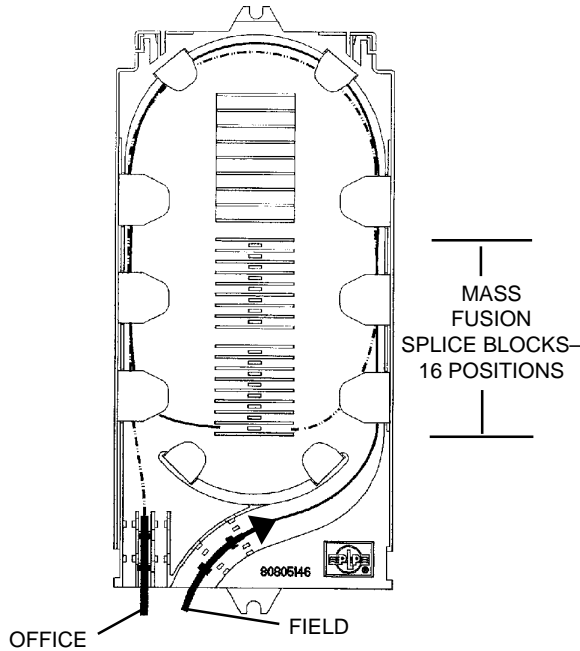

FIGURE 36 - ROUTING FIBERS IN THE MASS FIBER SPLICE TRAY FOR MASS FUSION

13.08 Splice fibers according to accepted company practices.

PLP TIP: If splice protectors loosely fit in the slots of the splice block, wrap each protector with felt tape to provide the desired fit **or** use a bead of silicone caulk to secure the connectors and place a strip of felt tape over the connectors and silicone caulk.

13.09 Replace all tray retaining tabs.

13.10 To replace tray cover, position pivotal arm on plastic cover underneath the hinges on the splice tray and snap into place. (Figure 37)

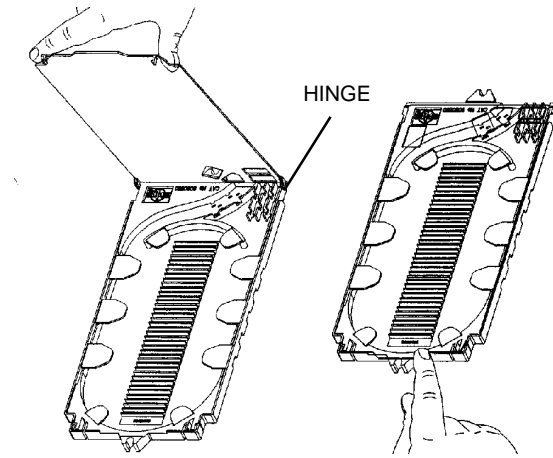

FIGURE 37 - REPLACE SPLICE TRAY COVER

14.00 SPLICE TRAY STORAGE AND TRANSPORT TUBE OR BUFFER TUBE ROUTING

14.01 Route the Transport Tubes of unitube-type cables alongside the Transition Compartment and stack Splice Trays on the threaded studs. (Figure 38)

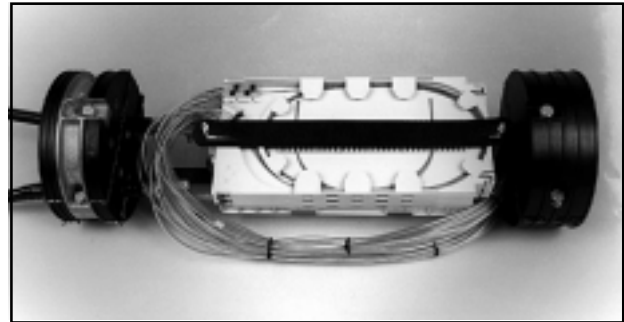

FIGURE 38 - ROUTING OF TRANSPORT TUBES AND SPLICE TRAY ORIENTATION

14.02 Route the buffer tubes of loose tube-type cables within the buffer tube storage clips and stack the splice trays on the threaded studs. (Figure 39)

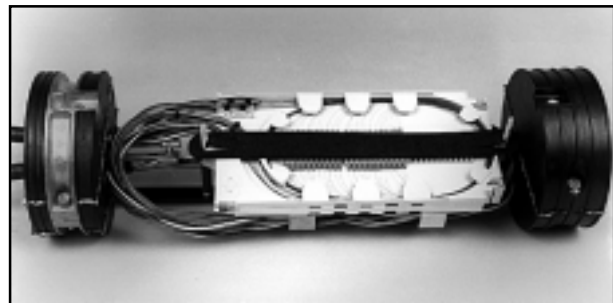

FIGURE 39 - ROUTING OF BUFFER TUBES AND SPLICE TRAY ORIENTATION

15.00 INSTALLING THE SPLICE CASE USING LOCKBAR FASTENING

15.01 The neoprene in the outer shells must be pliable when installed. In cold weather, for new installation or re-entry, warm outer shells prior to installation. Remove protective paper liners.

PLP TIP: Shells may be warmed in a truck cab or by placing near manhole vent hose. If space permits, bring the shells down into the manhole during splicing operation.

15.02 Aerial applications require that the suspension plates be installed to the back LOCKBAR Fastener prior to its application to the Splice Case. Special holes are provided on either side of the back LOCKBAR Fastening Assembly for this purpose. (Figure 40)

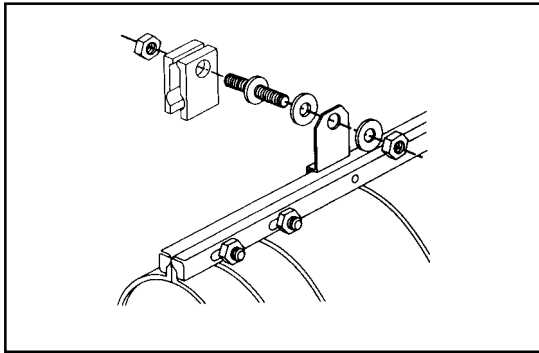

FIGURE 40 – AERIAL SUSPENSION PLATES

15.03 For external bonding, the bolt, bonding clip, and nut must be applied to the front (keyhole) LOCKBAR Assembly before mating it with the back LOCKBAR Assembly. Special holes are provided on either side of the front LOCKBAR Assembly for this purpose. The bolt head is applied inside the LOCKBAR Channel. The bonding clip and nut are applied to the bolt on the outside LOCKBAR Assembly face. Refer to Figure 41 for proper alignment of parts.

NOTE: The external bonding clamp **must** be used for all aerial, buried, and underground installations.

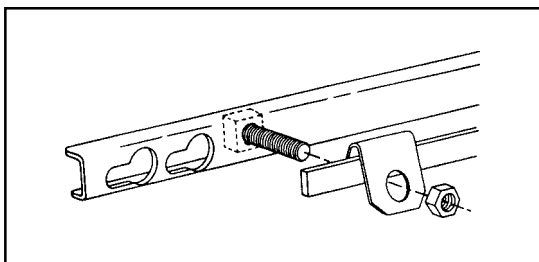

FIGURE 41 – PROPER ALIGNMENT OF PARTS

15.04 Now that all LOCKBAR System preparatory steps have been accomplished, apply the back shell half (without air flange) over End Plates.

15.05 Apply the front shell half (containing air flange).

15.06 NOTE: Prior to the application of the back LOCKBAR Assembly, be certain that the nuts are near the end of the threaded bolts. The ends of the threaded bolts have been treated so that the nuts remain on them and cannot be easily removed.

NOTE: Positioning tabs have been added to each LOCKBAR Fastener (front and back). These tabs should always point away from the Splice Case and will help assure proper alignment and eliminate the chance of a LOCKBAR Fastener being misapplied. (Figure 42)

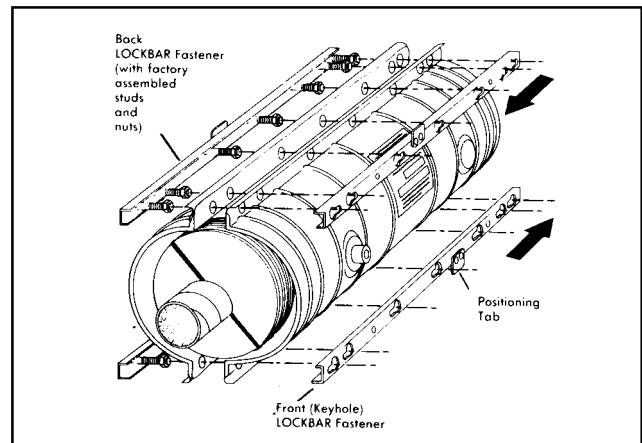

FIGURE 42 – LOCKBAR FASTENING

15.07 Install LOCKBAR Fastening system as shown in Figure 42. LOCKBAR Fastening consists of a (back) studded LOCKBAR Assembly with factory assembled threaded bolts and nuts, and a (front) keyhole LOCKBAR Assembly. The back LOCKBAR Assembly mates with the front LOCKBAR Assembly through the flange of the Splice Case shells, and then locks into position.

15.08 Tighten LOCKBAR Fastener in accordance with torque sequence label located on the front half of Splice Case.

15.09 Flash test all installations according to company practices. Be certain to replace the F pressure valve with the plug supplied with the case. If the installation necessitates the F valve is left on the case, be certain to use a new valve and do not scratch the plated surface.

15.10 After nuts have been tightened to the required torque value, a certain amount of relaxation occurs. This is to be expected. **DO NOT RE-TORQUE.** This can damage the Splice Case.

16.00 UNDERGROUND INSTALLATION

16.01 The Splice Case should be installed between the manhole racks.

16.02 COYOTE Splice Cases are very light and will float in a water-filled manhole. They must be tied down.

NOTE: It is recommended that the PREFORMED Splice Case Manhole Support, Catalog No. 80007614, be used to support and tie down the Splice Case.

17.00 AERIAL INSTALLATION

17.01 Place two lashing wire clamps (not supplied) on the suspension strand; (Figure 43) one directly above each aerial suspension plate that was placed in Step 15.02.

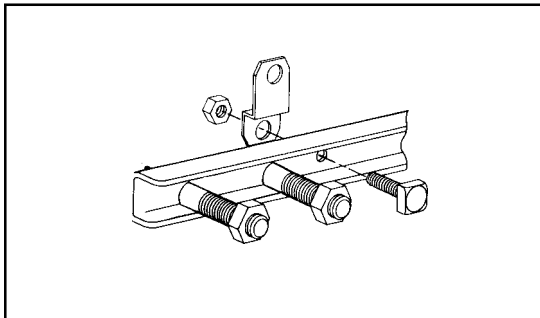

FIGURE 43 – AERIAL INSTALLATION

17.02 Be sure all nuts and washers are in their proper position. Tighten nuts securely.

18.00 EXTERNAL BONDING PROCEDURE

External bond methods will be shown, but company practices should be followed.

18.01 Select the external bonding clamp and bonding bolt from the package.

18.02 Loosely bolt the bonding clamp to one of the threaded inserts in the bottom section of the

End Plate where the cables were installed. Install a length of bonding ribbon (not supplied) from the bonding clamp on the LOCKBAR System to the bonding clamp on the End Plate. Securely tighten the bolt on the End Plate.

18.03 For manhole installations, extend a length of bonding ribbon from the bond clamp on the LOCKBAR Assembly to the bonding and grounding harness of the manhole. Securely tighten all connections.

18.04 For direct buried installations, extend a length of bonding ribbon (not supplied) from the bonding clamp on the LOCKBAR Assembly to a ground rod. Securely tighten all connections.

18.05 For aerial installations, the case is bonded to the suspension strand through the suspension plate assembly. Securely tighten all connections.

18.06 If cable contains metallic components, all cables must be bonded together. Remove bolt from threaded inserts on outside of End Plate, install continuous length of bonding ribbon through bonding clips and secure to End Plate with the End Plate bolts.

19.00 RE-ENTRY PROCEDURE

19.01 Loosen the nut on the external bonding clamp and remove bonding ribbon(s).

19.02 Loosen the nuts on the LOCKBAR System to allow removal of the LOCKBAR Assemblies.

NOTE: Do not unscrew nuts beyond the treated area. **DO NOT USE AIR WRENCHES** for this operation.

19.03 Remove the case halves.

19.04 If new cables are to be added, a new End Plate must be used. Remove all old sealing or LOCK-TAPE Sealant from the cables. Install new End Plate using the appropriate steps in this procedure.

20.00 MAINTENANCE PROCEDURES

20.01 The COYOTE Splice Case is designed for numerous re-entries. However, certain precautions must be taken prior to reapplication.

20.02 Be sure to clean shells and End Plates thoroughly to remove sand, dirt and other foreign substances.

20.03 Any bent studs or stripped nuts should be replaced. Only use hardware supplied by Preformed Line Products.

20.04 The shells should be lubricated prior to re-application. A uniform thin layer is all that is necessary. Only use lubrication supplied by Preformed Line Products (Catalog No. 80801566).

20.05 Any shells that are bent or distorted should not be used.

20.06 Prior to reinstallation, the neoprene on the shells should be allowed to return to its original state. Warming the shells speeds up the process.

21.00 MEASURING CABLE FOR OLD TYPE POWER END PLATE CUTTER AND BLADE KIT

21.01 Measure each cable at the location the End Plates will be applied using the Fiber Optic Measure Tape.

21.02 To use the Fiber Optic Measure Tape, hold the tape so the index line is facing you. Then wrap the tape around the cable tightly to obtain the reference number. (See Figure 5)

If the index line falls on a line between two numbers, always use the number to the right of the line. (Figure 44)

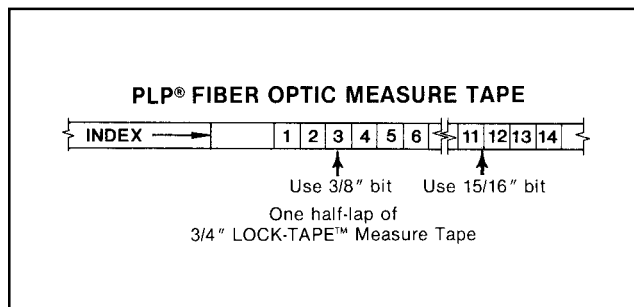

FIGURE 44 – FIBER OPTIC MEASURE TAPE

Once you have obtained the cable diameter reference number, use the blade size table to the right of the tape and locate that number. This will indicate the blade size to be used to drill the hole in the End Plate.

PLP TIP: Cable will vary in diameter from place to place along its length, so be sure to measure each cable at the area where the End Plate is to be placed.

22.00 SAFETY CONSIDERATIONS

22.01 This application procedure is not intended to supersede any company construction or safety standards. This procedure is offered only to illustrate safe application for the individual. Failure to follow these procedures may result in personal injury.

22.02 When working in the area of energized lines, extra care should be taken to prevent accidental electrical contact.

22.03 For proper performance and personal safety, be sure to select the proper size PREFORMED Product before application.

22.04 This product is intended for use by trained craftspeople only. This product **should not be used** by anyone who is not familiar with, and not trained to use it.

PREFORMED LINE PRODUCTS 
P.O. Box 91129, Cleveland, Ohio 44101 (440) 461-5200 www.preformed.com

SP2870-1