

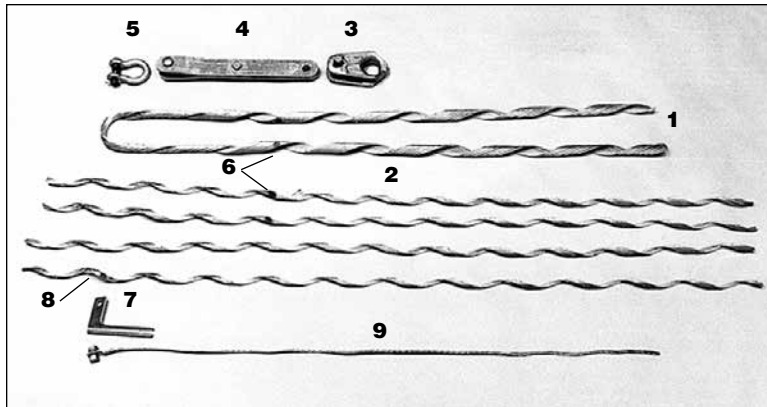

FIBERLIGN® Formed Wire Dead-end for OPGW



NOMENCLATURE

- 1. Dead-End Component:** Aluminum Covered Steel with Grit Applied
- 2. Structural Reinforcing Rods:** Aluminum Covered Steel with Grit
- 3. Thimble Clevis:** Galvanized Ductile Iron
- 4. Extension Link (option):** Extension Link & Pin are galvanized steel or galvanized ductile iron. A stainless steel cotter key is provided to capture the pin
- 5. Anchor Shackle (option):** Galvanized steel forging
- 6. Color Code And Crossover Marks**
- 7. Current Transfer Tab:** High Strength Aluminum Alloy
- 8. Current Transfer Tab Location Mark**
- 9. Grounding Wire Assembly (option):** Copper or aluminum conductor with aluminum compatible lug

APPLICATION

The FIBERLIGN Formed Wire Dead-end offers an alternate method for dead-ending OPGW. Unlike the FIBERLIGN® Dead-end “U-Bolt Type” design shown at the beginning of this section, the Formed Wire Dead-end uses two helically shaped formed wire components: an inner layer of Structural Reinforcing Rods and an outer layer Dead-end component. The FIBERLIGN® Formed Wire Dead-end does not provide take-up adjustment.

The formed wire inner and outer layer components are designed to transfer axial tensile loads and distribute radial compressive forces over the surface in contact with the OPGW to minimize effects on the central core and internal optical fibers.

Standard designs offered for left-hand lay single layer strand OPGW are listed in the table in this section. The standard Structural Reinforcing Rod component is right-hand lay and the standard Dead-end Component is left-hand lay.

The rated breaking strength of OPGW with multi-layer strand construction may exceed the rated holding strength of a Formed Wire Dead-end. Consult PLP before using this product for multi-layer applications.

Useful dimensions for VORTX™ damper placement are listed in the catalog table and shown in a reference drawing above the catalog table.

FIBERLIGN® Formed Wire Dead-end for OPGW



FIBERLIGN Formed Wire Dead-end Installed

Current Transfer Tab:

The Current Transfer Tab provides direct electrical bonding between the OPGW and a ground lead. The Structural Reinforcing Rod Layer conveniently applies proper compression to retain the current transfer tab against the OPGW without fasteners. The current transfer tab has a 1/2" diameter bolt hole to accommodate a standard 1/2"-13, UNC bolt for compatible ground lug attachment.

The standard current transfer tab accommodates left-hand lay OPGW and is rated for 80 kA²S to 150 kA²S depending on size of dead-end unit. Right-hand lay units for special applications are also available. Consult PLP for specifics.

Grounding Wire Assembly Options:

A 4' long ground wire with compression terminal, 1/2"-13 x 1" long bolt, 1/2"-13 nut, and lock washer can be provided. Two types of ground wire material are offered (copper or aluminum). To order the ground wire assembly with the Formed Wire Dead-end, add the appropriate suffix code to the catalog number (see catalog table in this section).

Component Strength:

The strength of the thimble clevis, extension link, and anchor shackle are designed to meet or exceed the maximum rated holding strength of 25,000 pounds.

Holding Strength:

Specific holding strengths on an OPGW cable will depend upon that cable's internal construction design and composition of the materials used for the individual strands. The highest holding capabilities exist with cable that use all aluminum clad steel strands in a single layer. Use of multi-layer and/or aluminum alloy strands may reduce holding capabilities. Consult PLP for information regarding holding abilities of the FIBERLIGN Formed Wire Dead-end for a specific OPGW design.

Lay Direction:

Left-hand lay is standard. Right-hand lay units for right-hand lay OPGW are available. Contact PLP with cable specifications for further information.

Attachment Fittings:

Dimensions of the thimble clevis provided (cat. no. TC-6F) are shown below. These are provided for proper selection of an extension link. PLP offers a 14" extension link as listed in the accessories section following the catalog table.

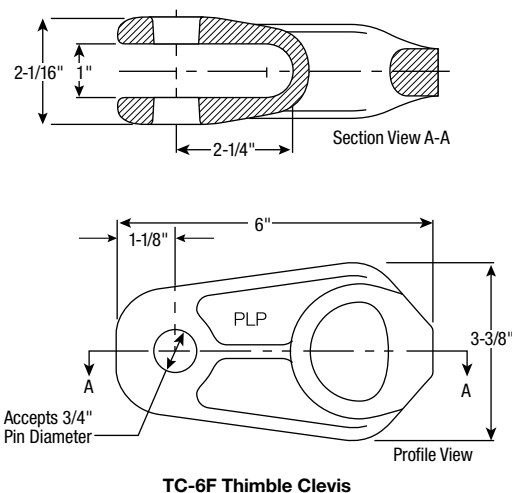

TC-6F Thimble Clevis

Component Reuse:

Once installed, structural reinforcing rods and dead-end components may be removed and reinstalled once for repositioning purposes; do not reuse after this initial installation. The hardware components may be reused as long as they are in good condition. Do not modify any components.



FIBERLIGN® Formed Wire Dead-end for OPGW

Ordering Instructions:

Select the appropriate FIBERLIGN Formed Wire Dead-end for OPGW from the following table in this section.

Accessories:

Ground wire assemblies and other hardware accessories may be ordered with the Formed Wire Dead-end by adding the appropriate SUFFIX CODE from the adjacent table. Note: Suffix code C4 is part of standard equipment and is included in the catalog number. The sequence for remaining accessory suffix codes is Extension Link "E2" followed by Anchor Shackle "S2" followed by Ground Wire Assembly "G" or "GA". Example – 2890001C4E2S2G includes a Formed Wire Dead-end with standard thimble clevis (C4), 14" extension link (E2), Anchor Shackle (S2) and copper ground wire assembly (G).

| Suffix Code | Description |
|-------------|--|
| E2 | 14" (356 mm) Extension Link (Catalog no. 00060132), 25,000# |
| S2 | Anchor Shackle (Catalog no. 72905002), 25,000# |
| G | 4' (1.212 m) long #4 (7W) Copper Ground Wire with terminal on one end. 1/2"-13x1-1/2" long galvanized steel bolt, hex nut and lock washer are included for attachment. (Catalog no. 710010015). Rated for 35 kA ² S. |
| GA | 4' (1.212 m) long 4/0 (7W) Aluminum Ground Wire with terminal on one end. 1/2"-13x1-1/2" long galvanized steel bolt, hex nut and lock washer are included for attachment. (Catalog no. 710010293). Rated for 80 kA ² S. |
| GA2 | 5' (1.5 m) long 95 mm ² (19w) Aluminum Ground wire with terminals at both ends. |

CAUTION: Determine appropriate material and size wire necessary to provide adequate grounding for your system before ordering the ground wire assemblies. For proper performance and personal safety be sure to select the proper ground wire before application.

| Catalog Number | Diameter Range | | | | Color Code | Rated Holding Strength* (Pounds) | Overall Structural Reinforcing Rod (SRR) Length in. (M) | Useful Dimensions for VORTX™ Damper Placement | | |
|----------------|----------------|-----------|-----------|-----------|------------|----------------------------------|---|---|---|----------------------------------|
| | Min. (in) | Max. (in) | Min. (mm) | Max. (mm) | | | | SRR Rod Diameter in. (mm) | Dead-end Component Length "L1" in. (mm) | Partial SRR Length "L2" in. (mm) |
| 2890020C4 | 0.355 | 0.399 | 9.0 | 10.1 | Blue | 20,000 | 44 (1.12) | .114 (2.9) | 34 (863) | 37.0 (939) |
| 2890001C4 | 0.4 | 0.449 | 10.2 | 11.4 | Blue | 20,000 | 49 (1.24) | .114 (2.9) | 36 (914) | 40.5 (1028) |
| 2890002C4 | 0.45 | 0.504 | 11.5 | 12.8 | Red | 25,000 | 54 (1.37) | .114 (2.9) | 39 (990) | 45.0 (1143) |
| 2890003C4 | 0.505 | 0.555 | 12.9 | 14.1 | Orange | 25,000 | 58 (1.47) | .114 (2.9) | 42 (1066) | 47.5 (1206) |
| 2890004C4 | 0.556 | 0.61 | 14.2 | 15.5 | Black | 25,000 | 63 (1.60) | .128 (3.2) | 45 (1143) | 51.5 (1308) |
| 2890005C4 | 0.611 | 0.68 | 15.6 | 17.2 | Green | 25,000 | 68 (1.73) | .128 (3.2) | 49 (1244) | 56.0 (1422) |
| 2890006C4 | 0.681 | 0.755 | 17.3 | 19.1 | Pink | 25,000 | 85 (2.16) | .144 (3.7) | 64 (1625) | 71.5 (1816) |
| 2890007C4 | 0.756 | 0.83 | 19.2 | 21.1 | Yellow | 25,000 | 91 (2.31) | .144 (3.7) | 68 (1727) | 76.0 (1930) |
| 2890008C4 | 0.831 | 0.925 | 21.2 | 23.5 | Brown | 25,000 | 98 (2.49) | .144 (3.7) | 73 (1854) | 81.5 (2057) |
| 2890009C4 | 0.926 | 1.03 | 23.6 | 26.2 | Purple | 25,000 | 107 (2.72) | .144 (3.7) | 79 (2006) | 89.5 (2273) |

*Based on OPGW with all aluminum clad steel strands in a single layer. Left hand lay standard.

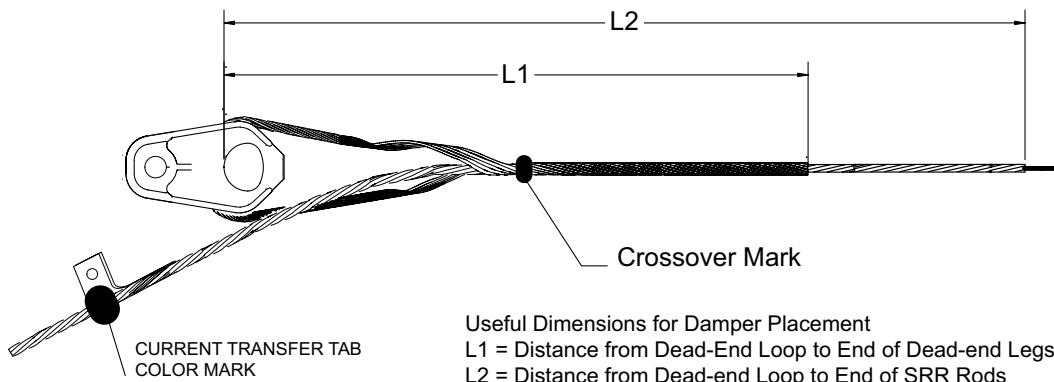

FIBERLIGN® Formed Wire Dead-end for OPGW

FIBERLIGN Formed Wire Dead-end Accessories

Extension Link with Pin and Cotter Key
suffix code **E2**, catalog number **LCE-66-14**

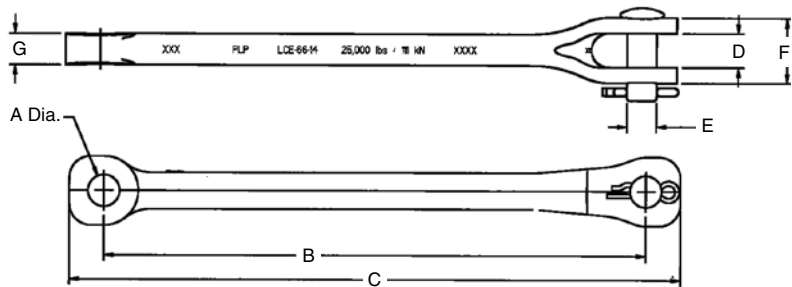

| A (Dia.) In. (mm) | B In. (mm) | C In. (mm) | D In. (mm) | E In. (mm) | F In. (mm) | G In. (mm) | Ultimate Tensile Strength (lbs.) |
|----------------------|---------------|----------------------|---------------|---------------|-------------------|----------------------|-------------------------------------|
| 13/16 (20.6) | 14 (356) | 16-1/2 max. (419) | 7/8 (22.2) | 3/4 (19.1) | 1-43/64 (42.5) | 51/64 max. (20.2) | 25,000 |

Anchor Shackle
suffix code **S2**, catalog number **AS-5L**

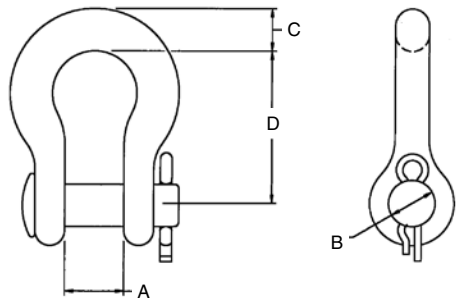

| A Max. Width of Opening Inches (mm) | B Max. Pin Diameter Inches (mm) | C Shackle Thickness Inches (mm) | D Inches (mm) | Ultimate Strength (kN) |
|--|---------------------------------------|---------------------------------------|------------------|------------------------------|
| 7/8" (22.2) | 5/8" (15.9) | 1/2" (12.7) | 2-23/32 (69.1) | 25,000 (111) |

Grounding Wire Assemblies

| Catalog Number | Suffix Code | Dimensions Inches | | | | Conductor | | Attachment Ground Bolt Size (supplied w/nut and lock washer) |
|----------------|-------------|-------------------|----------------------|---------------------|---------------------|-----------|--------------------------|--|
| | | L Length | D Conductor Diameter | d Lug Hole Diameter | e Lug Hole Diameter | Material | Type | |
| 710010015 | G | 48 (1.2 m) | .232 (6 mm) | 9/16 (14 mm) | - | Copper | #4 (7W) | 1/2"-13 x 1-1/2" long |
| 710010293 | GA | 48 (1.2 m) | .522 (13 mm) | 9/16 (14 mm) | - | Aluminum | 4/0 (7W) | 1/2"-13 x 1-1/2" long |
| 710011205 | GA2 | 60 (1.5 m) | .495 (12.5) | 17/32 (13.5 mm) | 11/16 (17.5 mm) | Aluminum | 95 mm ² (19W) | M12 x 30 mm long M16 x 38 mm long |
| 710012417 | - | 60 (1.5 m) | .528 (13.4) | 17/32 (13.5 mm) | 53/64 (21 mm) | Aluminum | 4/0 (19W) | M18 x 40 mm long |

Copper

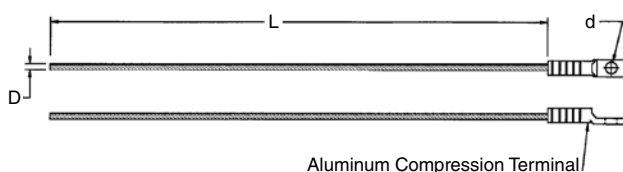

Aluminum

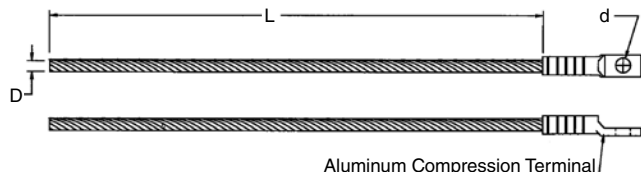

Light Duty Lattice Tower Clamp

Catalog No. 700011045

