



Thimble Clevis for Conductor Dead-ends

GENERAL RECOMMENDATIONS

Thimble Clevises are used in conjunction with PREFORMED Dead-ends on suspension-type or Dead-end insulators. The thimble is intended to provide a smooth internal contour to prevent stress concentration within the loop of a PREFORMED Dead-end. The Clevis includes a steel pin which links it through the eye of an insulator and secures it with a humpbacked cotter key.

If removal or replacement of an insulator, or similar maintenance, is required, only the cotter key and steel pin need to be removed to release the clevis.

The TC-17 Thimble Clevis can be used with all but the largest Distribution-Grips, all Overhead Dead-ends and Coated Dead-ends for conductors up to 0.783". The balance of the Dead-ends and Dead-ends for optical cable can be covered by the other listed Thimble Clevises. Refer to the tables entitled "Recommended Fitting" in the individual Dead-end sections for the appropriate application recommendations.

Catalog Number	Wt. Per Unit	Units Per Carton	RHS	Material
TC-5A	0.75 lb	25	12,000	Aluminum
ATC-20M	1.8 lb	25	20,000	Aluminum
TC-5F	1.6 lb	25	26,900	Iron
TC-17	1 lb	25	15,000	Iron
TC-6F	2.4 lb	25	42,400	Iron
TC-7F	7.3 lb	Bulk Package	60,000	Iron

Thimble Clevis for Conductor Dead-ends

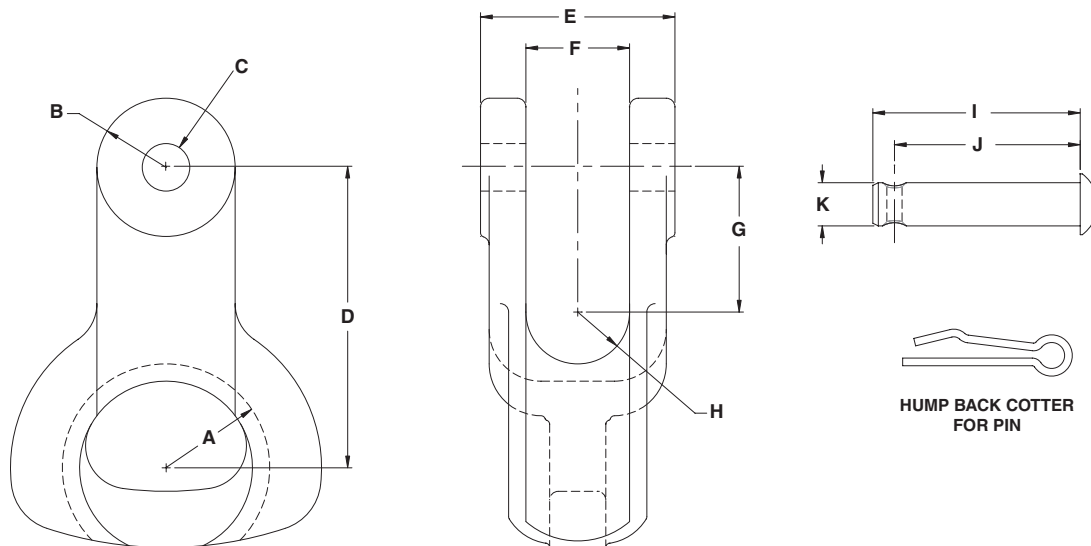

Catalog Number	Dimensions (Inches)										
	A	B	C Dia	D	E	F	G	H	I	J	K
TC-5A	1-1/8	1-1/4	11/16	3	1-3/4	15/16	1-13/32	1/2	2-15/16	2-3/16	5/8
ATC-20M	1-1/2	1	11/16	4-11/32	2-13/16	1-1/2	2-3/32	3/4	3-3/8	3-1/16	5/8
TC-5F	1-1/8	1-1/4	11/16	3	1-5/8	15/16	1-13/32	1/2	2-15/16	2-3/16	5/8
TC-17	13/16	3/4	11/16	2-5/16	1-3/8	3/4	1-1/8	3/8	1-7/8	1-5/8	5/8
TC-6F	1-1/4	1-1/2	13/16	3-1/2	2-1/16	1-1/16	1-23/32	17/32	2-3/4	2-7/16	3/4
TC-7F	1.40	1-1/2	1-1/16	4-1/4	3-1/2	2-1/4	2	3/4	25	4	1