

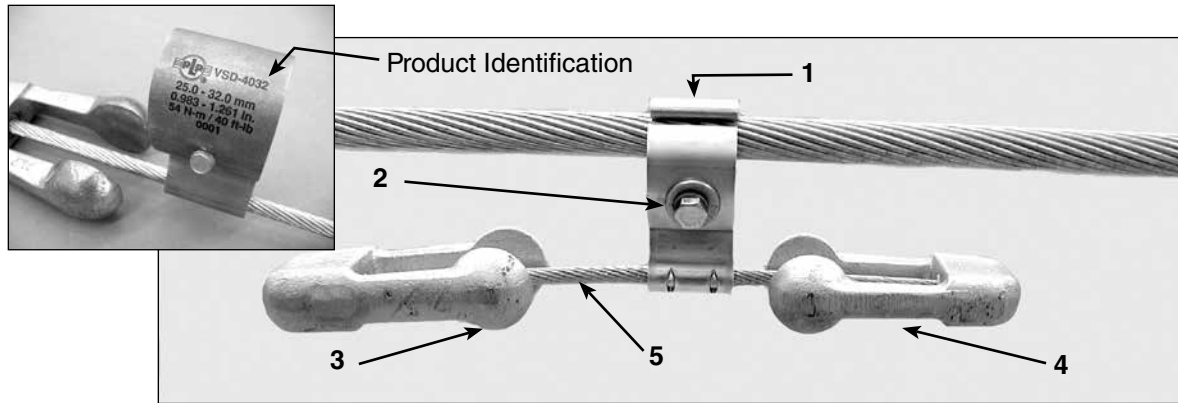

VORTX™ Vibration Damper



NOMENCLATURE

- 1. Clamp & Keeper:** The Clamp has an extruded hook shaped profile to hang onto the cable or conductor while tightening the keeper. Together, the aluminum keeper and clamp capture the conductor to hold the damper assembly firmly onto the conductor or cable. Product identification, installation torque, and lot number are permanently etched on the clamp.
- 2. Bolt, Washer, and Lock Washer:** The bolt, washer, and lock washer are used to fasten the keeper to the clamp and secure the entire damper assembly to the cable or conductor. The materials used are galvanized steel. An optional break-away bolt version is available.
- 3. Large Damper Weight:** The VORTX damper design shown above has two weight sizes – this provides up to 4 resonant response frequencies (two for the large weight and two for the small weight) for more effective protection. The weight is a galvanized ductile iron casting.
- 4. Small Damper Weight:** The small weight provides damping at higher frequencies. The weight is a galvanized ductile iron casting.
- 5. Messenger:** The messenger is made of formed hard steel wires that are galvanized for corrosion resistance.

Thermal Rating (Continuous) 250°C
***Protector Rods are required for ACCC, ACCR, Southwire C7, and HVCR C Conductors.**

GENERAL RECOMMENDATIONS

INTENDED USE: VORTX Dampers respond to wind induced line vibration that is characterized by high frequency, low amplitude motion a.k.a. aeolian vibration. The VORTX damper with Large and Small weights can achieve greater power dissipation and frequency response performance than “symmetrical weight” Stockbridge damper designs. Wider frequency coverage translates into better protection as energy is more effectively dissipated over the entire range of conductor/cable frequencies.

APPLICATION: VORTX Dampers can be clamped directly onto most aluminum based conductors including ACSR, AAC, AAAC, ACSS, and ACAR. PLP® Protector Rods should be considered but are not required for applications on aluminum conductors with relatively soft outer aluminum strand construction such as ACSS. *Protector Rods are required for ACCC, ACCR, Southwire C7, and HVCR C

Conductors. Protector rods are designed to reduce direct clamping stress on cable vulnerable to surface or core damage – this includes fiber optic cable designs such as ADSS and OPGW. Protector Rods are detailed on page 6-6.

CONDUCTOR/CABLE SIZE: Generally as conductors and cables increase in size they tend to vibrate at lower frequencies. The VORTX Damper is more effective for larger size conductors while the Spiral Vibration Dampers (SVD) are generally more effective for the smaller diameter cables that can vibrate at much higher frequencies. The following table provides a general recommendation for VORTX dampers and Spiral Vibration Damper’s based on conductor or cable size (see table on next page).

VORTX™ Vibration Damper

GENERAL RECOMMENDATIONS cont.

Application	Outer Diameter	Recommended Damper Product
Conductor OHSW and OPGW	up to 0.75" (19 mm)	SVD
	over 0.75" (19 mm)	VORTX
ADSS	up to 1.25" (32 mm)	SVD
	over 1.25" (32 mm)	VORTX

The degree of protection required on a specific line depends upon a number of factors such as line design, local climate, tension, exposure to wind flow, and line vibration history in the area. With assistance from your local PLP Sales Representative, the necessary information can be assembled for review and followed up with detailed PLP recommendations for your system.

DAMPERS PER SPAN: The recommended number of dampers per span depends on the amount of wind energy exposure and the conductor/cable characteristics. Self-Damping is a conductor or cable characteristic attributed to component material and construction – for example the individual metal strands that make up a conductor can move relative to one-another and dissipate energy (much the same way as the messenger does in the damper). Increasing line tension however, will decrease self-dampening as the individual strands begin to lock together.

Single Dampers are capable of a predetermined amount of energy dissipation that can protect spans approximately 300 meters (1000 feet) long or more considering self dampening. Longer spans may require more than one damper.

DAMPER PLACEMENT: VORTX dampers have specific performance characteristics that require strategic placement on the line to counter potential damage to the line system. Placement information shall be provided to assure that the damper will bring effective protection.

Placement information refers to locations A, B, C, and D for the first four dampers as measured from the respective hardware – See the sketch above. Longer spans that require additional protection may require dampers placed midspan. In many cases extremely long spans extend over rivers, and require additional protection due to high laminar wind speeds.

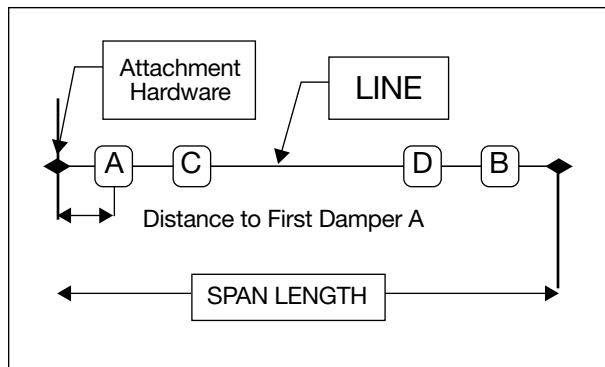

General Placement Sequence, Dampers A, B, C, and D placed 1st, 2nd, 3rd, and 4th respectively.

The general placement sequence is typical for spans with tangent hardware at both ends. Unlike tangent hardware, Dead-ends are not symmetric about the point of attachment to the structure – thus it is difficult to determine the most effective placement location for single dampers. If dampers must be placed at Dead-end hardware, the sequence requires dampers at A and C (or B and D) i.e. two dampers for single damper placement as shown below:

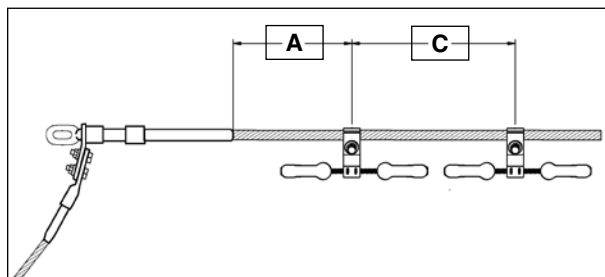

Compression Dead-end Damper Placement

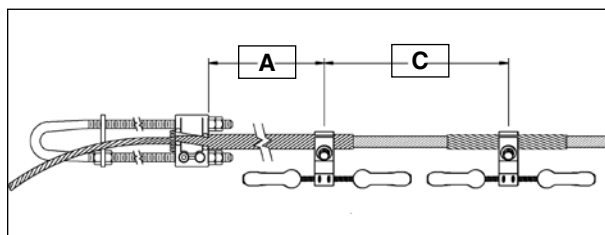

FIBERLIGN® Dead-end Damper Placement

PERFORMANCE QUALIFICATION: VORTX Dampers meet the requirements of International Standard IEC 61897. This standard includes levels of acceptable performance for Forced Response, Fatigue, Weight Pull-off, Messenger Pull-out, Damper Efficiency, Corrosion Resistance, Bolt Torque, Clamp Slip, and Corona. Response curves and test reports can be provided upon request.



VORTX™ Vibration Damper

VORTX DAMPER Catalog Number code:

VSD- 40 32 B

“VSD” – VORTX (Stockbridge) Damper

Weight Combination (20, 25, 35, 40, 50)

Weight selection is based on appropriate impedance for respective conductor or cable.

Clamp Code (16, 20, 25, 32, 40, 50, 61)

The clamp code represents the top end of the clamp range or maximum accepted cable diameter in millimeters.

Include only for optional design with break-away bolt.

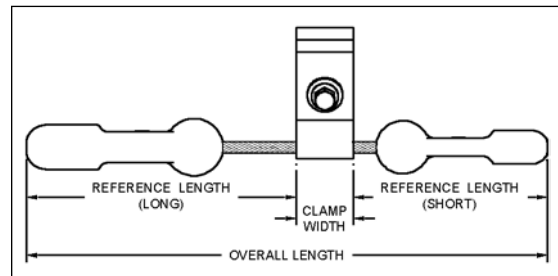

VSD20 Through VSD50 Series

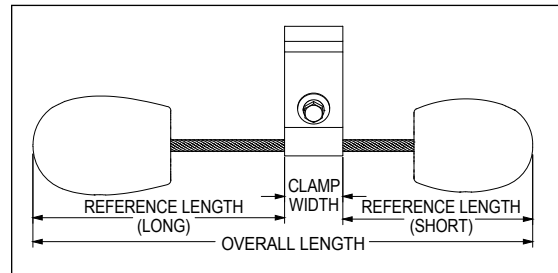

VSD55 Series

VORTX Damper Details for Conductor and Shield Wire Applications															
Catalog Number	Clamp Range Inches		Clamp Range mm		Overall Length		Reference Length Long		Clamp Width		Bolt Size	Install Torque		Assembled Weight	
	Min	Max	Min	Max	Inches	mm	Inches	mm	Inches	mm		mm	Ft-lb	N-m	lb
VSD-2016	0.483	0.612	12.3	15.5	14.6	370	6.9	175	1.630	41.4	M12 x 50	30	41	3.6	1.6
VSD-2020	0.612	0.786	15.5	20.0	14.9	379	6.9	175	2.000	50.8	M12 x 50	30	41	3.9	1.8
VSD-2025	0.786	0.983	20.0	25.0	14.9	379	6.9	175	2.000	50.8	M12 x 50	40	54	4.0	1.8
VSD-2032	0.983	1.261	25.0	32.0	15.1	384	6.9	175	2.200	55.9	M12 x 70	40	54	4.4	2.0
VSD-2040	1.261	1.579	32.0	40.1	15.3	389	6.9	175	2.380	60.5	M12 x 70	40	54	4.6	2.1
VSD-2050	1.579	1.970	40.1	50.0	15.4	392	6.9	175	2.500	63.5	M12 x 70	40	54	4.9	2.2
VSD-2520	0.612	0.786	15.5	20.0	12.7	322	6.4	161	2.000	50.8	M12 x 50	30	41	4.9	2.2
VSD-2525	0.786	0.983	20.0	25.0	12.7	322	6.4	161	2.000	50.8	M12 x 50	40	54	5.0	2.3
VSD-2532	0.983	1.261	25.0	32.0	12.9	327	6.4	161	2.200	55.9	M12 x 70	40	54	5.4	2.5
VSD-2540	1.261	1.579	32.0	40.1	13.1	332	6.4	161	2.380	60.5	M12 x 70	40	54	5.7	2.6
VSD-3525	0.786	0.983	20.0	25.0	14.7	374	7.0	179	2.000	50.8	M12 x 50	40	54	7.3	3.3
VSD-3532	0.983	1.261	25.0	32.0	14.9	379	7.0	179	2.200	55.9	M12 x 70	40	54	7.7	3.5
VSD-3540	1.261	1.579	32.0	40.1	15.1	384	7.0	179	2.380	60.5	M12 x 70	40	54	7.9	3.6
VSD-3550	1.579	1.970	40.1	50.0	15.2	387	7.0	179	2.500	63.5	M12 x 70	40	54	8.2	3.7
VSD-4032	0.983	1.261	25.0	32.0	20.3	515	10.5	267	2.200	55.9	M12 x 70	40	54	10.8	4.9
VSD-4040	1.261	1.579	32.0	40.1	20.4	519	10.5	267	2.380	60.5	M12 x 70	40	54	11.1	5.0
VSD-4050	1.579	1.970	40.1	50.0	20.6	523	10.5	267	2.500	63.5	M12 x 70	40	54	11.4	5.2
VSD-4061	1.970	2.422	50.0	61.5	21.1	535	10.5	267	3.000	76.2	M12 x 75	40	54	12.1	5.5
VSD-5040	1.261	1.579	32.0	40.1	23.9	606	12.1	307	2.380	60.5	M12 x 75	40	54	13.5	6.1
VSD-5050	1.579	1.970	40.1	50.0	24.0	609	12.1	307	2.500	63.5	M12 x 75	40	54	13.8	6.3
VSD-5061	1.970	2.422	50.0	61.5	24.5	622	12.1	307	3.000	76.2	M12 x 75	40	54	14.5	6.6
VSD-5543	1.500	1.700	38.1	43.2	21.6	548	11.2	285	2.61	66.3	M12 X 75	45	61	13.8	6.3
VSD-5549	1.700	1.950	43.2	49.5	21.8	553	11.3	286	2.75	69.9	M12 X 50	50	68	13.5	6.1

Shaded rows represent dampers that in most cases are directly applied to ACSR, ACAR, and AAAC conductors without armor or other protective rods.

Verify the appropriate weight code for the specific conductor in the catalog table entitled “Weight Combination for Conductor and Shield Wire Sizes” or otherwise contact PLP® technical support.

VSD55 designed for twin bundle 500KV AC Applications and EHV DC. Contact PLP® Technical support for final recommendations.

VORTX™ Vibration Damper

Weight Combination for Conductor and Shield Wire Sizes								
Weight Combination Code Number*	ACSR, AAC, AAAC and ACAR Range				Galvanized Steel and Alumoweld Range			
	Inches		mm		Inches		mm	
	Min.	Max.	Min.	Max.	Min.	Max.	Min.	Max.
20	0.473	0.720	12.0	18.2	.401	.486	10.2	12.3
25	0.721	0.858	18.3	21.8	.487	.650	12.4	16.5
35	0.859	0.983	21.9	24.9				
40	0.984	1.345	25.0	33.9				
50	1.346	1.602	32.1	40.7				
55	1.602	1.929	40.7	49				

*Final selection for weight combination at merging ranges are determined from conductor type and tension.

VSD55 designed for twin bundle 500kV AC Applications and EHV DC. Contact PLP® Technical support for final recommendation.

Weight Combination for OPGW				
Weight Combination Code Number*	Inches		mm	
	Min.	Max.	Min.	Max.
20	0.465	0.720	11.8	18.2
25	0.612	1.260	15.5	32.0
35	0.721	1.260	18.3	32.0

*Final selection for weight combination at merging ranges are determined from conductor type and tension.

Contact PLP® Technical Support for final recommendation.

Bolt Size and Torque Information									
Clamp Code	Clamp Range				Bolt Thread Size	Wrench Size		Torque	
	Millimeters		Inches			mm	In.	N-m	Ft-Lb
	Min.	Max.	Min.	Max.					
16	12.3	15.5	.483	.612	M12	19	3/4	41	30
20	15.5	20.0	.612	.786	M12	19	3/4	41	30
25	20.0	25.0	.786	.983	M12	19	3/4	54	40
32	25.0	32.0	.983	1.261	M12	19	3/4	54	40
40	32.0	40.1	1.261	1.579	M12	19	3/4	54	40
50	40.1	50.0	1.579	1.970	M12	19	3/4	54	40
61	50.0	61.5	1.970	2.422	M12	19	3/4	54	40



VORTX™ Vibration Damper

PROTECTOR RODS

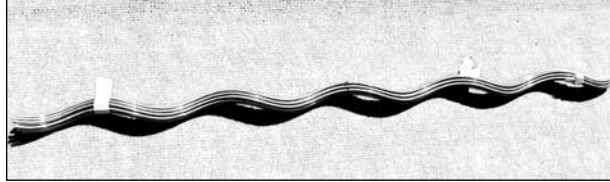

Thermal Rating (Continuous) 250°C

PROTECTOR RODS FOR VORTX DAMPER on OPGW or Special Conductors:

Protector Rods provide a layer of mechanical protection and reinforcement for accessory items such as VORTX Dampers that clamp onto a cable. This product is not designed for protection at clamp type supports or suspensions. Protector Rods are not to be used as a repair product as they are not

designed to restore conductance or tensile strength to a cable or conductor. Standard Protector Rods are designed for line voltages of 230 kV and lower. For higher voltage applications, Parrot Bill rod end treatment can be provided – contact PLP® for details.

PLP Protector Rods											
Catalog Number	Cable Diameter Range				Rod Length		Rod Diameter Inches (mm)	Rods Per Set	Color Code	Units Per Carton	Weight/ Carton Pounds (Kg)
	Inches		mm								
	Min.	Max.	Min.	Max.	Inches	mm					
PR-0135	0.378	0.423	9.6	10.7	12	304	0.121 (3.1)	11	Yellow	50	10 (4.5)
PR-0137	0.424	0.475	10.8	12.1	12	304	0.121 (3.1)	12	Brown	50	10 (4.5)
PR-0139	0.476	0.533	12.1	13.5	16	406	0.121 (3.1)	13	Blue	50	14 (6.4)
PR-0141	0.534	0.585	13.6	14.8	16	406	0.121 (3.1)	14	Green	50	14 (6.4)
PR-0142	0.586	0.618	14.9	15.6	16	406	0.146 (3.7)	13	Orange	50	21 (9.5)
PR-0144	0.619	0.667	15.7	16.9	16	508	0.146 (3.7)	14	Purple	50	21 (9.5)
PR-0146	0.668	0.722	17.0	18.3	20	508	0.146 (3.7)	15	Red	50	29 (13.1)
PR-0148	0.723	0.816	18.4	20.3	20	508	0.146 (3.7)	16	Black	50	29 (13.1)
PR-0150	0.817	0.898	20.8	22.7	20	508	0.146 (3.7)	17	White	50	31 (14.1)
PR-0151	0.899	0.954	22.8	24.2	24	610	0.167 (4.2)	17	Yellow	50	47 (21.3)
PR-0152	0.955	1.019	24.3	25.8	24	610	0.182 (4.6)	16	Brown	25	29 (13.1)
PR-0154	1.020	1.064	25.9	27.0	24	610	0.182 (4.6)	17	Blue	25	29 (16.1)
PR-0155	1.065	1.098	27.1	27.8	26	660	0.204 (5.2)	16	Green	25	36 (16.3)
PR-0156	1.099	1.181	27.9	29.9	26	660	0.250 (6.4)	14	Orange	25	48 (21.7)
PR-0158	1.182	1.298	30.0	32.9	26	660	0.250 (6.4)	15	Purple	25	51 (23.1)
PR-0160	1.299	1.415	33.0	35.9	26	660	0.250 (6.4)	16	Blue	20	44 (19.9)
PR-0162	1.416	1.543	36.0	39.2	26	660	0.250 (6.4)	17	Yellow	20	48 (21.7)
PR-0163	1.544	1.685	39.2	42.8	26	660	0.250 (6.4)	19	Brown	15	40 (18.1)
PR-0164	1.686	1.840	42.8	46.7	26	660	0.250 (6.4)	20	Blue	15	42 (19.0)